

H E A T





Sauna Heater Gracil standing version

Three-shell technology with inner shell made of hot-dip aluminised tin and stone basket as additional inner shell made of stainless steel. Outer mantle with anthracite pearl effect powder coating.

Sauna stones included,
Stone basket volume approx. 20 kg.
Connection 400 V 3 N AC 50 Hz.

Approx. dim.: H × W × D: 76 × 50.5 × 25 cm

- 1  6 kW (4 × 1.5 kW) Item-No. **9308-1**
- 2  7.5 kW (5 × 1.5 kW) Item-No. **9308-2**
- 3  9 kW (6 × 1.5 kW) Item-No. **9308-3**

Heating coil for sauna heater Gracil.

- 4  1.5 kW Item-No. **9308-99**



Sauna Heater Euro wall-mounted version

Three-shell technology with inner shell of hot-dip aluminised tin and stone basket as additional inner shell of stainless steel.

Cast iron cover, junction box at the rear. Base plate as drip tray construction. Outer casing stainless steel - plain.

Sauna stones included,
Stone basket volume approx. 15 kg.
Connection 400 V 3 N AC 50 Hz.

Approx. dim.: H × W × D: 61 × 46 × 35 cm,
height incl. feet 74 cm

- 5  7.5 kW (3 × 2.5 kW) Item-No. **9310-1**
- 6  9 kW (6 × 1.5 kW) Item-No. **9310-2**

Set of feet for floor mounting

- 7  optional Item-No. **9310-5**

Heating coil for sauna heater Euro.

- 8  specify kW number Item-No. **9310-99**



Electric
sauna heaters

item description	kW	item number	unit price	from 3 pieces	from 10 pieces	from 25 pieces	from 50 pieces
1	6 kW	9308-1					
2 Sauna Heater Gracil, standing version	7.5 kW	9308-2					
3	9 kW	9308-3					
4 Heating Coil for Sauna Heater Gracil	1.5 kW	9308-99					
5 Sauna Heater Euro, wall-mounted version	7.5 kW	9310-1					
6	9 kW	9310-2					
7 Set of Feet, for floor mounting		9310-5					
8 Heating Coil for Sauna Heater Euro		9310-99					

All prices apply only to industry, trade, craft and commerce and are subject to VAT ex warehouse. No minimum quantity surcharge.

Sauna Heater P 1+ standing version

Outer casing in anthracite pearl effect powder coating. Inner shell made of stainless steel. Robust, very stable and service-friendly construction for private and commercial use. Flat construction.

Sauna stones included,
Stone basket volume approx. 40 kg.
Connection 400 V 3 N AC 50 Hz.

Approx. dimensions: H × W × D: 72 × 63 × 38 cm

①  12 kW (6 × 2.0 kW) Item-No. 9311-1

②  15 kW (6 × 2.5 kW) Item-No. 9311-2

Heating coil for sauna heater P 1+.

③  specify kW number Item-No. 9311-99

Sauna Heater Saunadome II standing version

Sauna heater with open stone basket on all 4 sides. The metal grid prevents the stones from falling out.

Extra large stone basket, completely made of stainless steel, corner profiles in anthracite pearl effect, top parts in brushed stainless steel, adjustable feet for installation on uneven surfaces.

Sauna stones included, stone basket volume apr. 100 kg.
Connection 400 V 3 N AC 50 Hz.

Approx. dimensions: H × W × D: 100 × 41 × 41 cm

④  9 kW (9 × 1.0 kW) Item-No. 9309-1

⑤  12 kW (8 × 1.5 kW) Item-No. 9309-2

⑥  15 kW (10 × 1.5 kW) Item-No. 9309-3

⑦  18 kW (12 × 1.5 kW) Item-No. 9309-4

Heating coil for sauna heater Saunadome II

⑧  specify kW number Item-No. 9309-99



Data sheets available for each heater.

item description	kW	item number	unit price	from 3 pieces	from 10 pieces	from 25 pieces	from 50 pieces
① Sauna Heater P 1+, standing version	12 kW	9311-1					
②	15 kW	9311-2					
③ Heating Coil for Sauna Heater P 1+		9311-99					
④	9 kW	9309-1					
⑤ Sauna Heater Saunadome II, standing version	12 kW	9309-2					
⑥	15 kW	9309-3					
⑦	18 kW	9309-4					
⑧ Heating Coil for Sauna Heater Saunadome II		9309-99					

All prices apply only to industry, trade, craft and commerce and are subject to VAT ex warehouse. No minimum quantity surcharge.



Sauna Heater FinnRock standing version

Sauna heater with open stone basket at the front. The metal grid prevents the stones from falling out.

Also suitable for installation in front of glass surfaces and in the middle of the sauna.

Sauna stones included,
Stone basket volume approx. 40 kg.
Connection 400 V 3 N AC 50 Hz.

Apr. dim.: H × W × D: 76 × 41.3 × 38.5 cm

- 1  7.5 kW (5 × 1.5 kW) Item-No. **9314-1**
- 2  9 kW (6 × 1.5 kW) Item-No. **9314-2**
- 3  12 kW (6 × 2.0 kW) Item-No. **9314-3**

Heating coil for sauna heater FinnRock

- 4  specify kW number Item-No. **9314-99**



Sauna Heater Goliath HD



Very sturdy, reinforced construction. Completely made of stainless steel. Wall construction in 3-shell technique.

Outer shell anthracite powder coating. With extra large stone basket. Low operating and maintenance costs.

Standard wiring made of solid copper power rails. Particularly suitable for intensive commercial use.

Sauna stones included,
Stone basket volume approx. 75 kg.
Connection 400 V 3 N AC 50 Hz.

Approx. dim.: H × W × D: 83 × 96 × 47 cm

- 5  18 kW (18 × 1 kW) Item-No. **9315-1**
- 6  24 kW (18 × 1.33 kW) Item-No. **9315-5**
- 7  30 kW (18 × 1.66 kW) Item-No. **9315-6**
- 8  36 kW (18 × 2 kW) Item-No. **9315-7**

Heating coil for sauna heater Goliath HD.

- 9  kW-Zahl angeben Item-No. **9315-99**

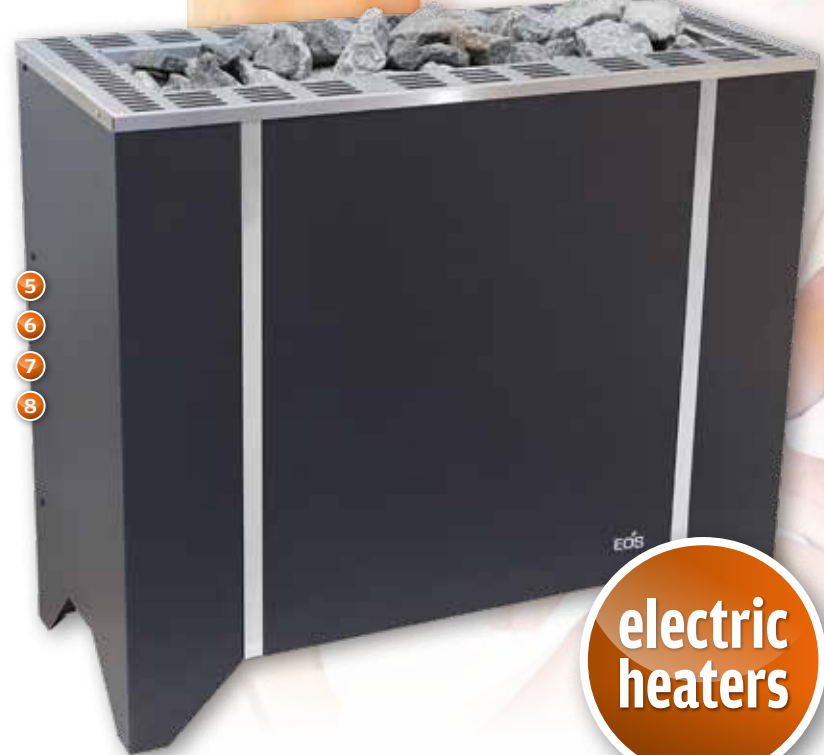

item description	kW	item number	unit price	from 3 pieces	from 10 pieces	from 25 pieces	from 50 pieces
1	7.5 kW	9314-1					
2 Sauna Heater FinnRock, standing version	9 kW	9314-2					
3	12 kW	9314-3					
4 Heating Coil for Sauna Heater FinnRock		9314-99					
5	18 kW	9315-1					
6 Sauna Heater Goliath HD	24 kW	9315-5					
7	30 kW	9315-6					
8	36 kW	9315-7					
9 Heating Coil for Sauna Heater Goliath HD		9315-99					

All prices apply only to industry, trade, craft and commerce and are subject to VAT ex warehouse. No minimum quantity surcharge.



Sauna control units

Sauna Control Unit Econ D2

Electronic control unit with 24h real and preselection clock. Control range between 30 and 115 °C. Safety temperature limiter 139 °C. Heating time limit in short-time mode 6 h, extendable to 12 h.

Switching load 9 kW, extendable with PCU. Digital display of time, preset time, temperature and remaining time. Including key lock/child lock. Temperature sensor and sensor cable (2 m) included in delivery.

Connection 400 V 3 N AC 50 Hz

Approx. dimensions: H × W × D: 22 × 25 × 6.7 cm



Item-No. 9340-5

Sauna Control Unit Econ D4

as above, but heating time limit is extendable to infinite.

Optional connection of an additional bench sensor possible. Prepared for remote control. Optionally with remote start module. Dimmable cabin light - 10 steps. Output for cabin fan, adjustable (3 steps).

Connection 400 V 3 N AC 50 Hz

Approx. dimensions: H × W × D: 22 × 25 × 6.7 cm



Item-No. 9340-7



Do you need replacement heating coils for your EOS sauna heater?
Just send an email to info@finnsa.de.



Switching load extensions

LSG 10

For extending the switching load by 10 kW. In combination with control units with 9 kW (10 kW). Suitable for sauna heaters wired in two circuits with up to 19 kW (20 kW) total output.

Approx. dimensions: H × W × D: 22 × 25.5 × 6.5 cm



Item-No. 9370-4

LSG 18

For extending the switching load to a total of max. 27 kW. In connection with control units with 9 kW switching capacity of the Econ series.

Only sauna heaters wired in two circuits (max. 9 kW + 18 kW) may be connected.

Approx. dimensions: H × W × D: 27 × 30 × 10 cm



Item-No. 9370-2

LSG 36

as above, but switching load can be extended to a total of max. 36 kW.

Only sauna heaters wired in two circuits (max. 2 × 18 kW) may be connected.

Approx. dimensions: H × W × D: 45 × 30 × 14.2 cm



Item-No. 9370-3

item description	type	item number	unit price	from 3 pieces	from 10 pieces	from 25 pieces	from 50 pieces
1 Sauna Control Unit	Econ D2	9340-5					
2	Econ D4	9340-7					
3	LSG 10	9370-4					
4 Switching Load Extension	LSG 18	9370-2					
5	LSG 36	9370-3					

All prices apply only to industry, trade, craft and commerce and are subject to VAT ex warehouse. No minimum quantity surcharge.

Bi-O Max Standing Heater combi heater with vaporiser

High-quality heater with integrated evaporator for flexible climate forms. For private and commercial use. To be used with EOS combination control units.

Cover made of die-cast aluminium. Outer shell anthracite powder coating. Inner shell stainless steel.

Sauna stones included.

Filling amount 8 l, stone basket volume apr. 60 kg.

Connection 400 V 3 N AC 50 Hz.

Approx. dimensions: H × W × D: 92.5 × 50 × 50 cm.

- 1 9 kW (9 × 1 kW + 2 kW*) Item-No. 9322-1
- 2 12 kW (9 × 1.33 kW + 2 kW*) Item-No. 9322-2
- 3 15 kW (9 × 1.67 kW + 2 kW*) Item-No. 9322-3

* vaporiser capacity

Heating coil for sauna heater Bi-O Max.

- 4 specify kW number Item-No. 9322-99

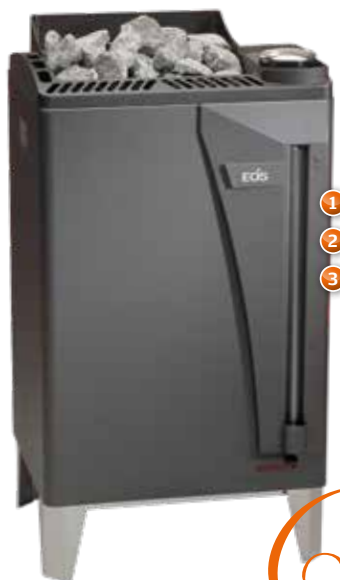

Bi-O

sauna

Fixed Water Connection for automatic filling

For sauna heaters with vaporiser.

- 5 FWC 01 (without illustration) Item-No. 9380



electronic
heaters with
vaporiser

Rear Wall Heater Bi-O Mat U combi heater with vaporiser

Can be mounted behind a partition wall with 22 cm wall clearance and is hence particularly space-saving and safe. To be used with EOS combi control units.

Outer and inner casing completely made of stainless steel. Wooden funnel and connection hose for infusions included. Including protective grille.

Sauna stones included.

Filling amount approx. 5 l,

Stone basket volume approx. 15 kg.

Connection 400 V 3 N AC 50 Hz.

Approx. dimensions: H × W × D: 100 × 112 × 20 cm.

- 6 7.5 kW (5 × 1.5 kW, + 1.5 kW*) Item-No. 9330-2
- 7 9 kW (6 × 1.5 kW, + 1.5 kW*) Item-No. 9330-3
- 8 12 kW (8 × 1.5 kW, + 2 kW*) Item-No. 9330-4

* vaporiser capacity

Heating coil for sauna heater Bi-O Mat U.

- 9 specify kW number Item-No. 9330-99

item description	kW	item number	unit price	from 3 pieces	from 10 pieces	from 25 pieces	from 50 pieces
1	9 kW	9322-1					
2 Bi-O Max Standing Heater	12 kW	9322-2					
3	15 kW	9322-3					
4 Heating Coil for Sauna Heater Bi-O Max		9322-99					
5 Fixed Water Connection f. Heaters w/ Vaporiser		9380					
6	7.5 kW	9330-2					
7 Rear Wall Heater Bi-O Mat U	9 kW	9330-3					
8	12 kW	9330-4					
9 Heating Coil for Sauna Heater Bi-O Mat U		9330-99					

All prices apply only to industry, trade, craft and commerce and are subject to VAT ex warehouse. No minimum quantity surcharge.



Combi control units (sauna + vaporiser)

Combi Control Unit Econ H2

With 24h real time clock and preselection clock. For sauna (40 - 115°C) and sauna with humidity mode (30 - 70°C). Safety temperature limiter 139°C.

Digital display of time, temperature, humidity and remaining time. Including temperature sensor, sensor cable and key lock/child safety lock.

Temperature preselection, 10-step humidity control with low-water detection, reheating & fan function. Heating time limit in short-time mode 6 h, extendable to 12 h. Switching load 9 kW, extendable with PCU. Vaporiser capacity up to 3 kW.

Connection 400 V 3 N AC 50 Hz

Approx. dimensions: H × W × D: 22 × 25 × 6.7 cm.

1 **Item-No. 9350-4**

Combi Control Unit Econ H4

as above, but heating time limit extendable to infinite, as well as prepared for optional connection of a bank and/or humidity sensor.

With output for optional remote control & cabin fan, dimmable cabin light 10-level, with holiday home mode (restricted access).

Connection 400 V 3 N AC 50 Hz

Approx. dimensions: H × W × D: 22 × 25 × 6.7 cm.

2 **Item-No. 9350-6**



Our vaporiser systems are specially adapted to the Econ H2 and H4 combi control units.



Switching load extensions

LSG 10

For extending the switching load by 10 kW. In combination with control units with 9 kW (10 kW). Suitable for sauna heaters wired in two circuits with up to 19 kW (20 kW) total output.

Apr. dim.: H × W × D: 22 × 25.5 × 6.5 cm

3 **Item-No. 9370-4**

LSG 18 H

For extending the switching load by max. 18 kW furnace and 4 kW vaporiser capacity. In combination with control units of the Econ series.

Only connect sauna heaters wired in two circuits (max. 9 kW + 18 kW).

Apr. dim.: H × W × D: 27 × 30 × 10 cm.

4 **Item-No. 9372-2**

LSG 36 H

as above, but extension of the switching load by max. 36 kW heater output.

Only connect sauna heaters wired in two circuits (max. 2 × 18 kW).

Apr. dim.: H × W × D: 45 × 30 × 14.2 cm.

5 **Item-No. 9372-3**



Humidity Sensor F2

Incl. sensor housing and 4 m silicone cable. For better control of humidity in combination with the Econ H4 control unit.

Apr. dim.: 4,5 × Ø 4.5 cm.

6 **Item-No. 9371-1**



Bench Sensor 2nd temperature sensor

Incl. sensor housing and 6 m silicone cable for more precise temperature control in combination with the Econ D4 and Econ H4 control units.

Apr. dim.: 4,5 × Ø 4.5 cm.

7 **Item-No. 9371-3**

item description	type	item number	unit price	from 3 pieces	from 10 pieces	from 25 pieces	from 50 pieces
1 Combi Control Unit	Econ H2	9350-4					
2 Combi Control Unit	Econ H4	9350-6					
3 Switching Load Extension	LSG 10	9370-4					
4 Switching Load Extension	LSG 18 H	9372-2					
5 Switching Load Extension	LSG 36 H	9372-3					
6 F2 Humidity Sensor		9371-1					
7 Bench Sensor, 2nd temperature sensor		9371-3					

All prices apply only to industry, trade, craft and commerce and are subject to VAT ex warehouse. No minimum quantity surcharge.

Fire hazard averted!



The switch-off rockers for sauna heaters

According to DIN EN 60335, commercially used sauna heaters must be equipped with switch-off rockers. Supplement or retrofit your EOS heating system.

Switch-Off Rocker

Safety protection for sauna heaters. Automatic switch-off for wall installation as extended safety function in case of pressure load. Heater mounting set on request.

If the cover protection is pressed down, the heating process is interrupted. If the object is removed, operation is continued.

Switch-Off Rocker Type 1

For sauna heaters Euro, FinnRock.
Apr. dim.: H x W x D: 14 x 32.8 x 32.2 cm.

1 Item-No. 9300-1

Switch-Off Rocker Type 3

For sauna heater P 1+.
Apr. dim.: H x W x D: 14 x 72.8 x 32.2 cm.

2 Item-No. 9300-2

Switch-Off Rocker Type 4

For sauna heaters BI-O Max, Saunadome II.
Apr. dim.: H x W x D: 14 x 32.8 x 48.2 cm.

3 Item-No. 9300-3

Switch-Off Rocker Type 5

For sauna heater Goliath HD.
Apr. dim.: H x W x D: 14 x 72.8 x 48.2 cm.

4 Item-No. 9300-4

Switch-Off Rocker Type 6

For sauna heater Gracil.
Apr. dim.: H x W x D: 14 x 32.6 x 22.2 cm.

5 Item-No. 9300-5

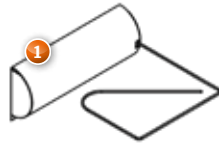

Switch-Off Rocker Type 1

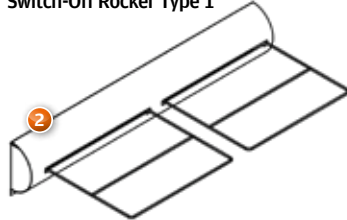

Switch-Off Rocker Type 3



Switch-Off Rocker Type 4

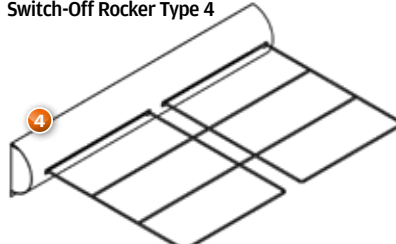

Switch-Off Rocker Type 5



Switch-Off Rocker Type 6

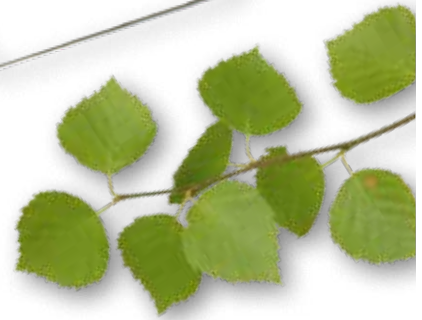

Heater Sensor spare sensor

Spare heater sensor incl. safety temperature limiter. Each Econ sauna control unit is equipped with a heater sensor.

Approx. dimensions: 4.5 x ø 4.5 cm.

6 Item-No. 9371-2

item description	item number	unit price	from 3 pieces	from 10 pieces	from 25 pieces	from 50 pieces
1	type 1	9300-1				
2	type 3	9300-2				
3 Switch-Off Rocker	type 4	9300-3				
4	type 5	9300-4				
5	type 6	9300-5				
6 Heater Sensor, spare sensor	9371-2					

All prices apply only to industry, trade, craft and commerce and are subject to VAT ex warehouse. No minimum quantity surcharge.

The correct Utilization for a long runtime

What you need to consider with...

... sauna heaters

Keep the following in mind for the longest possible life of your sauna heater:

- Supply and exhaust air in the sauna cabin is imperative so that the air can circulate well
- Water should not get on the heating coil
- Use decalcified water for vaporiser systems with water hardness > 1
- When operating with vaporiser systems, the max. permissible temperature must be in relation to a certain air humidity



In the table below you will find the heating power required for your cabin size and the minimum power supply cross-section required.

... sauna stones

9 out of 10 heater or heating coil defects are due to sauna stones that have not been "maintained". In addition, old stones take on odours and thus falsify the scent of your sauna infusion - as do residues.

For all types of sauna stones, please note the following:

- Clean with water before use, then allow to dry well.
- Do not pour water on cold stones. The water settles into cracks and can cause the stone to burst when heated.
- Only carefully douse hot stones with warm water.
- Do not carry out experiments with alcohol or unsuitable liquids or solids.
- Reposition the stones from time to time and remove small stones and crumbs. Pile up the stones so that the air can circulate well.

Stones are a natural product - splintering cannot be ruled out due to extreme heating and cooling.

heating power in kW	cabin size in m ³ (basis manufacturing according to RAL for cabins in buildings)										minimum cross-section of the mains power in mm ²	
	7 - 10	9 - 14	14 - 18	18 - 25	24 - 30	24 - 34	35 - 40	40 - 50	50 - 65	65 - 75	connection to 400 V 3 N AC	fuse protection A
7.5											5 × 2.5 ²	3 × 16
9.0												
12.0											5 × 4 ²	3 × 25
15.0												
18.0											5 × 6 ²	3 × 35
21.0												
24.0											5 × 10 ²	3 × 50
27.0												
30.0											min. 5 × 10 ²	3 × 63
36.0												

Sauna stones

heart of the heater

FINNSA Sauna Stones



Special plutonic rock. In the FINNSA range for over 40 years. Ideal infusion stone for all sauna heaters.

You can also get our sauna stones in practical nylon fabric big bags on pallets.

ATTENTION: Fork-lift truck required on site.



Sauna Stones, medium

Sauna stones with a grain size of approx. 60 - 120 mm.

- 1  10 kg carton, approx. 15-20 pieces Item-No. 6995
- 2  20 kg carton, approx. 30-35 pieces Item-No. 6990
- 3  250 kg big bag Item-No. 6992

Sauna Stones, large

Sauna stones with a grain size of approx. 60 - 200 mm.

- 4  20 kg carton, approx. 10-15 pieces Item-No. 6991
- 5  250 kg big bag Item-No. 6993

FINNSA Sauna Stones reddish porphyry

These sauna stones offer an extremely soft sauna infusion and are ideal for all sauna heaters.

Sauna stones with grain size of approx. 40 - 130 mm.

- 6  20 kg Karton Item-No. 6970
- 7  250 kg Big Bag Item-No. 6970-2



Sauna stones play a major role in the quality of every sauna session.

Make sure that your stones are regularly checked, re-stacked and replaced.

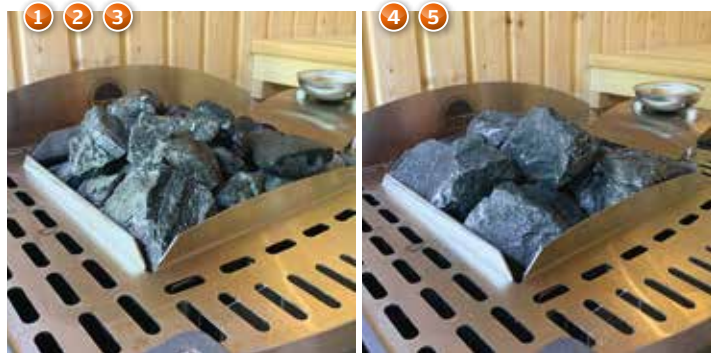

medium size

large size



item description	weight	item number	unit price	from 3 pieces	from 10 pieces	from 25 pieces	from 50 pieces
1	10 kg	6995					
2 FINNSA Sauna Stones, medium	20 kg	6990					
3	250 kg	6992					
4 FINNSA Sauna Stones, large	20 kg	6991					
5	250 kg	6993					
6 FINNSA Sauna Stones, reddish porphyry	20 kg	6970					
7	250 kg	6970-2					

All prices apply only to industry, trade, craft and commerce and are subject to VAT ex warehouse. No minimum quantity surcharge.

Sauna Soapstones from Finland

Soapstone stores an enormous amount of heat. You thus achieve a very pleasant climate as well as gentle, very even infusions.

Attention: Do not place soapstone directly next to the heating coils.

①  15 kg carton Item-No. 0860





Original Ceramic Sauna Stones "Kerkes"

The sauna stones are burned at approx. 1300 °C. This makes them extremely resistant and ideal for the sauna. They store the heat extremely well.

The spheres are particularly suitable for wooden sauna heaters. The tetras are ideal for electric heaters. Use the larger Kerkes in the lower area and a layer of small Kerkes on top.

Generally 10 kg in a package.

②  tetras, ø 60 mm, approx. 35 pieces Item-No. 1220

③  tetras, ø 80 mm, approx. 20 pieces Item-No. 1221

④  spheres, ø 50 mm, approx. 60 pieces Item-No. 1225

⑤  spheres, ø 60 mm, approx. 35 pieces Item-No. 1226



A large proportion of Finnish sauna baths use Kerkes stones.

item description	item number	unit price	from 3 pieces	from 10 pieces	from 25 pieces	from 50 pieces
① Sauna Soapstones from Finland	0860					
②	tetras, small	1220				
③ Ceramic Sauna Stones "Kerkes"	tetras, large	1221				
④	spheres, small	1225				
⑤	spheres, large	1226				

All prices apply only to industry, trade, craft and commerce and are subject to VAT ex warehouse. No minimum quantity surcharge.

Evaporator Stone "Saunakko"

Place in the sauna stones in as hot a place as possible and fill with infusion water.

Enjoy your little sauna geyser.

Approx. dimensions: 6 cm high.



Item-No. 0810

Steam Stones with holes

Steam stones with four cavities for infusion water. This product gives you a pleasant, even humidity in the sauna.

Approx. dimensions: 6 cm high.

Total content of all holes approx. 150 ml.



2 stones

Item-No. 0820

Sauna Ghost "Löylynhenki"

Place the "ghost" on your stove and pour some water into its lap.

Approx. dimensions: ø 8.5 cm, 11 cm high.



Item-No. 0825

Fountain "Saunatroikka"

Place the Saunatroikka on your sauna heater. Like a fountain, 3 water columns form and bubble depending on the temperature of the stones.

Approx. dimensions: ø 8.5 cm, 9.5 cm high.



Item-No. 0840

Soapstone Lamp "Mystic"

Great soapstone lamp for tea lights.

Approx. dimensions: 8 cm high.



Item-No. 0836



item description	item number	unit price	from 3 pieces	from 10 pieces	from 25 pieces	from 50 pieces
1 Evaporator Stone "Saunakko"	0810					
2 Steam Stones with Holes	0820		set of 2			
3 Sauna Ghost "Löylynhenki"	0825					
4 Fountain "Saunatroikka"	0840					
5 Soapstone Lamp "Mystic"	0836					

All prices apply only to industry, trade, craft and commerce and are subject to VAT ex warehouse. No minimum quantity surcharge.

Exclusive Solid Wood Sauna Lamp "Malmö" wall/corner model made of obeche wood

This lamp can be easily retrofitted in any sauna. The ceiling light 8021 is included in the scope of delivery.

The supplied mounting block can be attached to the sauna wall with 2 screws. The lampshade is hung there and can be removed at any time without tools.

Complete with shade, mounting block and interior light 8021.

Approx. dimensions: W × H × D: 25.5 × 38 × 12.5 cm, Side: 3.1 cm, cover board: 2.2 × 23.2 cm.

1  complete Item-No. 7065

as above, but only shade with mounting block.

2  shade + mounting block Item-No. 7065-1

Wall mounting with mounting block

Corner mounting with mounting block

quality sauna

Lights

by FINNSA

Wall Shade "Salo" lampshade

Solid alder wood, cleanly finished, can be combined with the 4 ceramic lamps offered below.

Approx. dimensions: W × H × D: 30 × 32 × 16 cm.

3  Item-No. 8850

Corner Shade "Oslo" lampshade

as above, but corner shade.

Approx. dimensions: B × H × T: 27 × 32 × 12.5 cm

4  Item-No. 8851

item description	item number	unit price	from 3 pieces	from 10 pieces	from 25 pieces	from 50 pieces
1 Sauna Lamp, Wall/Corner Model "Malmö"	complete	7065				
2	shade	7065-1				
3 Wall Shade "Salo"		8850				
4 Corner Shade "Oslo"		8851				

All prices apply only to industry, trade, craft and commerce and are subject to VAT ex warehouse. No minimum quantity surcharge.

FINNSA brings *Light* into the dark

Sauna Corner Lamp "Porvoo"

High-quality, very stable corner lamp with low installation depth. Suitable for ambient temperatures up to 115 °C.

Scope of delivery: Facing shade, metal wall bracket, interior lamp 1110 and fixing material.

Socket E14. Up to 30 W. Only use candle-shaped light sources.

① + complete (IP44) Item-No. 1125

② + spare wooden shade Item-No. 1112

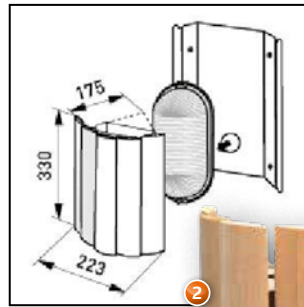

Sauna Wall Lamp "Mikkeli"

as above, but wall-mounted.

③ + complete (IP44) Item-No. 1120

④ + spare wooden shade Item-No. 1111

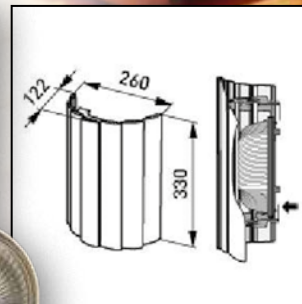

Spare Interior Light "Porvoo" & "Mikkeli"

Heat-resistant plastic base with cover glass. Max. 30 W, E 14, suitable up to max. 115° C. IP44.

Use only candle-shaped bulbs.

Apr. dim.: L × W × H = 20 × 10 × 8 cm.

⑤ + Item-No. 1110

item description	item number	unit price	from 3 pieces	from 10 pieces	from 25 pieces	from 50 pieces
① Sauna Corner Lamp, "Porvoo"	complete	1125				
②	shade	1112				
③ Sauna Wall Lamp, "Mikkeli"	complete	1120				
④	shade	1111				
⑤ Spare Interior Light "Porvoo" and "Mikkeli"		1110				

All prices apply only to industry, trade, craft and commerce and are subject to VAT ex warehouse. No minimum quantity surcharge.



Sauna Wall Lamp "Quadro"

Robust and timeless sauna lamp. Heat-resistant plastic base suitable up to 125 °C. E 27, 40 or 60 Watt. Glass shade ø 19,4 cm.

1 + complete (IP44) Item-No. 1130

2 + spare shade Item-No. 1131

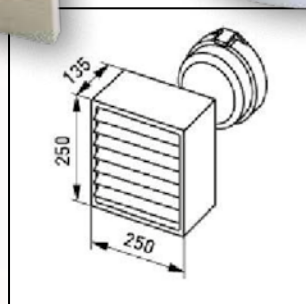

Spare Interior Light for "Quadro"

Heat-resistant plastic base with large glass cover. Suitable up to 125 °C. E27, 40 or 60 Watt.

IP44, apr. dim.: ø 19.5 cm, H 10.5 cm.

3 + Item-No. 1132

Sauna Interior Lamp "Raita"

Attractive, practical, versatile and easy to mount. Wall or corner mounting possible.

The shade is adjustable and consists of 5 pine wood veneer layers. Untreated, can be tinted.

Suitable up to 125 °C. E 27, 40 Watt.

Apr. dim.: W × H × D: 15.7 × 23 × 11 mm.

4 + complete (IP44) No. 111010

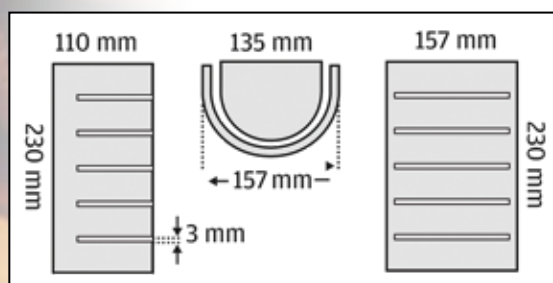

Only have installed by an expert. Installation with distance to the ceiling to avoid heat accumulation.

Energy-saving bulbs are not suitable for sauna lighting. Please use only commercially available incandescent or oven bulbs.

item description	item number	unit price	from 3 pieces	from 10 pieces	from 25 pieces	from 50 pieces
1 Sauna Wall Lamp, "Quadro"	complete 1130					
2	shade 1131					
3 Spare Interior Light "Quadro"	1132					
4 Sauna Interior Lamp, "Raita"	complete 111010					

All prices apply only to industry, trade, craft and commerce and are subject to VAT ex warehouse. No minimum quantity surcharge.

Sauna Lights

Ceramic base white with glass. Suitable up to max. 125 °C. When used as a ceiling lamp max. 40 W E27, when used as a wall lamp max. 60 W E27.

Approx. dim.: 13 cm long, ø glass 8.5 cm

1  bevelled, IP54 frosted **Item-No. 8020**

as above, but with clear glass.

2  bevelled, IP54 clear **Item-No. 8020-1**

as above, but 13.5 cm long and straight.

3  straight, IP54 frosted **Item-No. 8021**

as above, but with clear glass.

4  straight, IP54 clear **Item-No. 8021-1**

Light Bulb for sauna lamps

Designed for high temperatures, these bulbs are ideal for saunas. Round ball shape.

Individually packed in carton. Energy efficiency class E. 230 V, 40 W, up to 300 °C.

5  E 14 **Item-No. 8051**

6  E 27 **Item-No. 8052**

Halogen Bulb for sauna light 1110

Halogen. Candle shape. Individually packed in cardboard box. Energy efficiency class C.

E14, 230 V, 28 W corresponds to 35 W, Length approx. 10 cm incl. thread

7  E 14 **Item-No. 8053**

Halogen Bulb

Halogen. Drop shape. Individually packed in cardboard box. Energy efficiency class C.

E27, 230 V, 28 W corresponds to 35 W, Length approx. 7,5 cm incl. thread

8  E 27 **Item-No. 8054**



All illuminants are only available while stocks last.

Illuminants are excluded from the warranty.

item description	item number	unit price	from 3 pieces	from 10 pieces	from 25 pieces	from 50 pieces
1 Sauna Light, bevelled	frosted 8020					
2	clear 8020-1					
3 Sauna Light, straight	frosted 8021					
4	clear 8021-1					
5 Sauna Light Bulb, ball shape	E 14 8051					
6	E 27 8052					
7 Halogen Light Bulb, candle shape	E 14 8053					
8 Halogen Light Bulb, drop shape	E 27 8054					

All prices apply only to industry, trade, craft and commerce and are subject to VAT ex warehouse. No minimum quantity surcharge.



Holzrahmen aus Erle.

red, embodies passion, fire and power and is said to have a vitalising effect.

yellow, the color of the sun, is supposed to liven us up and make our mood cheerful.

green, provides mental balance as the basic color of nature.

blue, the color of the sky and the sea, is said to promote relaxation.

More information at www.collaxx.com.

Installation

collaxx colour light units are ideal for retrofitting: Simple mounting with two screws.

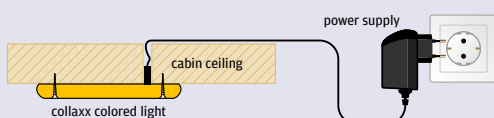

... how *Colors* affect *Humans*

LED technology - unique, economical and innovative.

Activate your energy centres with the positive effect of light.

- absolutely flicker-free
- homogeneous luminous surface
- 30.000 hours LED life

collaxx coloured lights convince with radiant advantages



Temperature resistant up to 125°C

The unique HEAT PROOF TECHNOLOGY.



High luminosity

Intensive luminosity. Suitable for all types of infrared and sauna cabins.



Light properties

8 colors. Smooth color transitions. All models dimmable.



Water and steam resistant

Color light unit and radio remote control.



Large saunas

Switch several colored lights in parallel with one remote control.



Service

At www.collaxx.com you can download relaxation journeys under "Moodies" and use the "Farbfibel" to find out how the colors effect us.







Colored Lights

FL2000F-F4-R1 classic proven design

With its gently rounded edges, this classic blends harmoniously into the cabin.

- For cabins up to 3.5 × 3.5 m floor space
- Switch & dim via radio remote control
- Adjust the lamps brightness
- 90 Power LED's by Osram

Apr. dim.: 36.3 × 26.7 × 3.5 cm, 950 g, 34 Watt, Standard power cord approx. 1.80 m.

1	 alder	Item-No. 8330
2	 obeche	Item-No. 8330-2
3	 cedar	Item-No. 8330-3
4	 aspen	Item-No. 8330-4

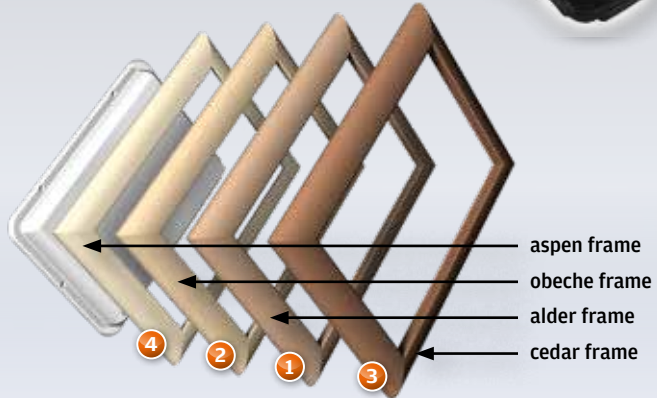

FL201VF+F4 can be integrated almost seamlessly

- For cabins up to 2.5 × 2.5 m floor space
- only 3.5 mm protrusion
- Switch & dim via radio remote control
- Adjust the lamps brightness
- 56 Power LED's by Osram

Apr. dim.: 32 × 23.5 × 3.5 cm, 600 g, 21 Watt, Ceiling cut-out: 30 × 21.5 cm, Standard power cord approx. 1.80 m.

5	 alder	Item-No. 8322
---	-------------------------------------------------------------------------------------------	---------------



color examples

item description	material	item number	unit price	from 3 pieces	from 10 pieces
1	alder	8330			
2	collaxx Colored Light	8330-2			
3	FL2000F-F4-R1, classic	8330-3			
4	alder	8330-4			
5	collaxx Coloured Light FL201VF+F4, seamless	8322			

All prices apply only to industry, trade, craft and commerce and are subject to VAT ex warehouse. No minimum quantity surcharge.

FL2000WF-F4

steam bath proof: waterproof

- For cabins up to 3.5 × 3.5 m floor space
- Switch & dim via radio remote control
- Adjust the lamps brightness
- 90 Power LED's by Osram

Apr. dim.: 33.6 × 24.1 × 3,5 cm, 900 g, 34 Watt,
Standard power cord approx. 1.80 m.

① without frame Item-No. 8335



FL201F+F4

with striking edges

- For cabins up to 2.5 × 2.5 m floor space
- No ceiling cut-out required
- Switch & dim via radio remote control
- Adjust the lamps brightness
- 56 Power LED's by Osram

Apr. dim.: 32 × 23.5 × 3.5 cm, 730 g, 21 Watt,
Standard power cord approx. 1.80 m

② alder Item-No. 8321

FL202F+F4

slim and modern design

- For cabins up to 2.5 × 2.5 m floor space
- Invisible mounting - only 33 mm height
- Switch & dim via radio remote control
- Adjust the lamps brightness
- 56 Power LED's by Osram

Apr. dim.: 27.5 × 19 × 3.3 cm, 450 g, 21 Watt,
Standard power cord approx. 1.80 m.

③ obeche Item-No. 8323

④ acacia steamed Item-No. 8323-2



item description	material	item number	unit price	from 3 pieces	from 10 pieces
① collaxx coloured light FL2000WF-F4, waterproof	without frame	8335			
② collaxx coloured light FL201F+F4, striking	alder	8321			
③ collaxx coloured light FL202F+F4, modern	obeche	8323			
④	acacia	8323-2			

All prices apply only to industry, trade, craft and commerce and are subject to VAT ex warehouse. No minimum quantity surcharge.

Round Colored Light for small saunas and infrared cabins

- For cabins up to 1.3 × 1.3 m floor space
- Standard power cord approx. 1.40 m

FL50T

Simple touch operation - color change by touch.

Approx. dimensions: ø 13.5 × 3.5 cm, 125 g

1  max. 16 Watt Item-No. 8340

FL50F+F4

as above, but with remote control. Several FL50F can be combined.

Approx. dimensions: ø 13.5 × 3.5 cm, 125 g

2  max. 16 Watt Item-No. 8341



Hand-held Remote Control 4-button radio remote control

- operating modes: single color/automatic, color, brightness, dimming
- stepless dimming, 7 colors adjustable
- programmable automatic mode
- easy to retrofit
- wireless
- maintenance-free operation due to long-life battery
- can be combined with all collaxx devices

Approx. dimensions: 7.5 × 3.9 × 1.6 cm, 40 g

Please keep the remote control in a safe place and do not throw it away!

3  Item-No. 8380



Wall-mounted Remote Control for mounting inside and outside the cabin

as above, but wall-mounted.

Beech, mountain spruce and ash version available with delivery time.

Approx. dimensions: 5.5 × 5.5 × 1 cm, 40 g

4  alder Item-No. 8380-2

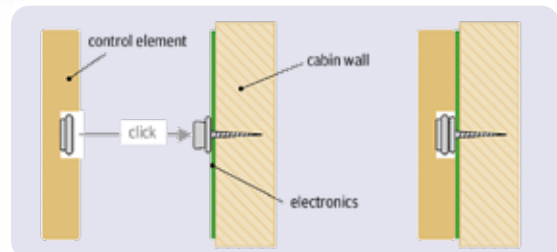

item description	item number	unit price	from 3 pieces	from 10 pieces
1 collaxx Colored Light, round	FL50T 8340			
2	FL50F+F4 8341			
3 Hand-held Remote Control	8380			
4 Wall-mounted Remote Control	8380-2			

All prices apply only to industry, trade, craft and commerce and are subject to VAT ex warehouse. No minimum quantity surcharge.

Modular Colored Light Strips for all types of saunas and infrared cabins

Indirect lighting behind the backrests or in the ceiling area.
Mounting in the visible area by cover clips.

All units are supplied with silicone connecting cables in standard length. Cables in other lengths are available for all units on request.

- directly stackable & flush mountable
- modular design due to Z-routing of the cable
- suitable for temperatures up to 125°C
- smooth color transitions, dimmable



4 × LL49F + F4

incl. 4 × 49 cm, silicone cable, remote control and power supply unit.

1 24 LED Watt **Item-No. 8360**

8 × LL22F + F4

incl. 8 × 22 cm, silicone cable, remote control and power supply unit.

3 16 LED Watt **Item-No. 8362**

2 × LL49F + F4

incl. 2 × 49 cm, silicone cable, remote control and power supply unit.

2 12 LED Watt **Item-No. 8361**

4 × LL22F + F4

incl. 4 × 22 cm, silicone cable, remote control and power supply unit.

4 8 LED Watt **Item-No. 8363**

2 × LL22F + F4

incl. 2 × 22 cm, silicone cable, remote control and power supply unit.

5 4 LED Watt **Item-No. 8364**

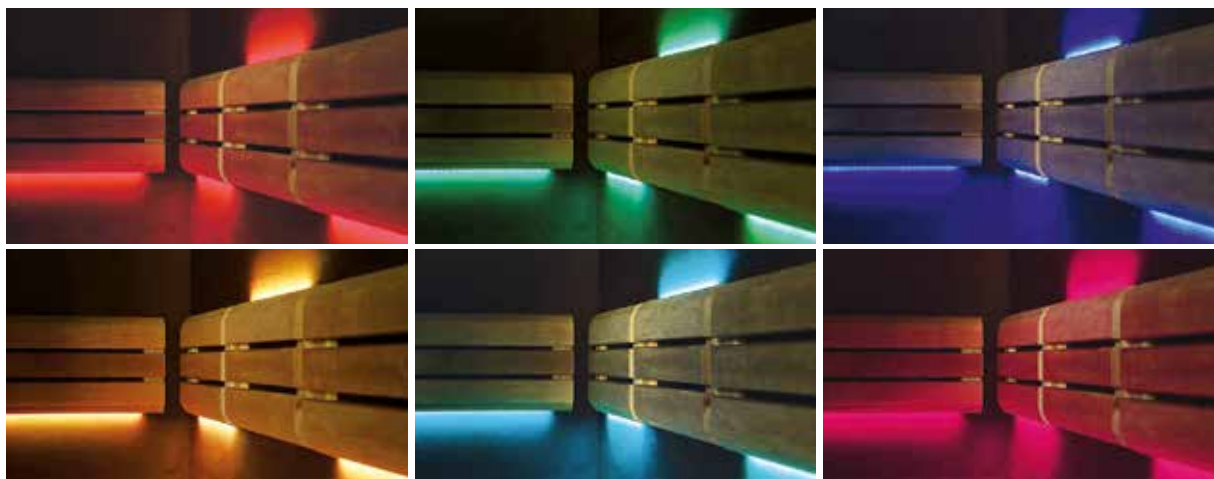

item description	item number	unit price	from 3 pieces	from 10 pieces
1	4×LL49F+F4	8360		
2	2×LL49F+F4	8361		
3 collaxx Modular Colored Light Strips	8×LL22F+F4	8362		
4	4×LL22F+F4	8363		
5	2×LL22F+F4	8364		

All prices apply only to industry, trade, craft and commerce and are subject to VAT ex warehouse. No minimum quantity surcharge.

Let your Creativity run free...

Continuous Colored Light Strips for all types of saunas and infrared cabins

- direct and indirect lighting in the visible area
- can be recessed flush with the surface
- can be combined with all other collaxx products
- connection via DC socket
- incl. silicone connection cable
- suitable for temperatures up to 125 °C
- smooth color transitions, dimmable

Approx. dimensions: 1.5 × 1.5 cm



Mounting with Retaining Clips

Easy to mount using the transparent retaining clips supplied.

Approx. dimensions: W × H: 1.9 × 1.75 cm.

Connection

Recommended connection with DC socket.



Please note when placing your order:

- radio / wall-mounted remote control (see right) must be ordered separately (not included in the price)
- it is possible to connect several light strips. To do this, specify "light strip with DC socket on both sides" and order the required silicone connecting cable (see right) separately (not included in the price)
- with a DC socket on both sides, the light strip is 1 cm longer
- please also specify the desired length of the silicone connection cable (already included in the price)



Ideal: Send us a dimensioned sketch of your sauna cabin via e-mail to info@finnsa.de. We will put it together for you and make you a non-binding offer.

item description	item number	unit price	from 3 pieces	from 10 pieces
1 collaxx Continuous Colored Light Strips	LS 20 cm	8366		
2	LS 38 cm	8366-02		
3	LS 47 cm	8366-03		
4	LS 56 cm	8366-04		
5	LS 65 cm	8366-05		
6	LS 74 cm	8366-06		
7	LS 83 cm	8366-07		
8	LS 92 cm	8366-08		
9	LS 101 cm	8366-09		
10	LS 110 cm	8366-10		

All prices apply only to industry, trade, craft and commerce and are subject to VAT ex warehouse. No minimum quantity surcharge.



Silicone Connection Cable for Light Strips

These silicone connection cables are suitable for use inside the sauna cabin and especially for commercial saunas.

- 21** 3 m, incl. DC adapter Item-No. **8350**
- 22** 10 m, incl. DC adapter Item-No. **8351**
- 23** 0.35 m Item-No. **8352**

Why is the remote control battery not replaceable?

- users would have to reliably perform a reset
- seal can only be inserted with special device
- housing not designed for frequent opening/closing
- moisture can corrode battery holder
- necessary battery is not available in retail

However, if everything has been done correctly, the battery will last a sauna lifetime anyway. The energy lasts for well over 15 years and beyond a million key-strokes.

A normal battery holder would encourage many to insert standard button cells. However, these are only suitable up to 70 °C. Acid could leak out or they could explode.

item description	item number	unit price	from 3 pieces	from 10 pieces
collaxx Continuous Colored Light Strips	LS 119 cm	8366-11		
	LS 128 cm	8366-12		
	LS 137 cm	8366-13		
	LS 146 cm	8366-14		
	LS 155 cm	8366-15		
	LS 164 cm	8366-16		
	LS 173 cm	8366-17		
	LS 182 cm	8366-18		
	LS 191 cm	8366-19		
	LS 200 cm	8366-20		
21 Silicone Connecting Cable	3 m	8350		
22 Silicone Connecting Cable	10 m	8351		
23 Silicone Connecting Cable	0.35 m	8352		

All prices apply only to industry, trade, craft and commerce and are subject to VAT ex warehouse. No minimum quantity surcharge.

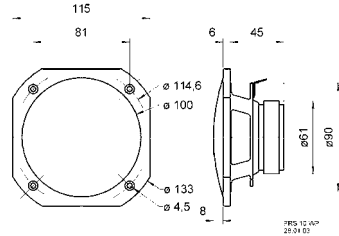

Technical data:
 Rated load-carrying capacity 25 Watt
 Maximum power handling 50 Watt
 Impedance 8 Ω
 Frequency range (-10 dB) 90-19000 Hz
 Average sound pressure level 90 dB (1 W/1 m)
 Net weight 360 g

Full-range Loudspeaker FRS 10 WP for sauna, 10 cm (4")

With glass fibre cone, plastic basket and grate, balanced frequency response, high efficiency, good mid- and high-frequency reproduction.

Due to permanent weather resistance, especially suitable for outdoor installations, swimming pools, saunas and as built-in speakers for boats, ships and open vehicles.

- Functional at low temperatures
- Suitable for use in damp locations, seawater-proof
- 120 °C temperature-resistant, plastic: PC (UL 94: V-0)

1 white Item-No. 5950-1

2 black Item-No. 5950-2

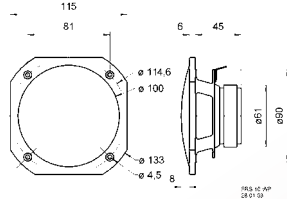

Technical data:
 Rated load-carrying capacity 40 Watt
 Maximum power handling 60 Watt
 Impedance 4 Ω
 Frequency range (-10 dB) 70 - 16000 Hz
 Average sound pressure level 85 dB (1 W/1 m)
 Net weight 290 g

Full-range Loudspeaker FR 13 WP universal, 13 cm (5")

With injection-moulded plastic cone and plastic basket and grate. Corrosion- and water-proof due to magnet cladding and silicone coating of the supply cable. Clear high-frequency reproduction. Suitable for outdoor installations.

- Functional at low temperatures
- Suitable for use in damp locations, seawater-proof
- 80 °C temperature-resistant, plastic: ASA (UL 94: HB)

3 white Item-No. 5952-1

4 black Item-No. 5952-2

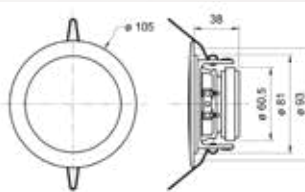
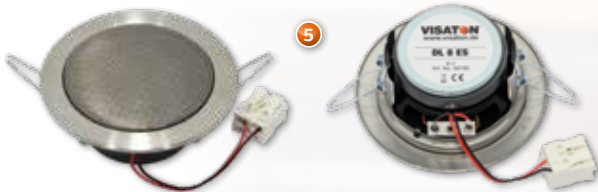

Technical data:
 Rated load-carrying capacity 10 Watt
 Maximum power handling 30 Watt
 Impedance 8 Ω
 Frequency range (-10 dB) 100-2000 Hz
 Average sound pressure level 84 dB (1 W/1 m)
 Net weight 330 g

Ceiling Loudspeaker DL 8 ES universal, 8 cm (3,3")

Ceiling speaker made of stainless steel with brushed finish. Suitable for installation in suspended ceilings of all materials. Efficient mounting in circular hole cut-out with spring clips, electrical connection with compression spring clip.

- Functional at low temperatures
- Suitable for outdoor use, UV-resistant
- Installation in suspended ceilings in damp rooms and heat cabins

5 brushed stainless steel Item-No. 5954

item description	color	item number	unit price	from 3 pieces	from 10 pieces	from 25 pieces	from 50 pieces
1 Loudspeaker FRS 10 WP	white	5950-1					
2 Loudspeaker FRS 10 WP	black	5950-2					
3 Loudspeaker FR 13 WP	white	5952-1					
4 Loudspeaker FR 13 WP	black	5952-2					
5 Loudspeaker DL 8 ES	stainless steel	5954					

All prices apply only to industry, trade, craft and commerce and are subject to VAT ex warehouse. No minimum quantity surcharge.