



**W
A
T
E
R**

Kneipp Hose without wall holder

Union nut, double-walled, food-safe. With metal outlet sleeve. All connecting parts made of stainless steel.

Spout sleeve fits exactly in solid metal wall holder item-no. 3227/3229. Not included in delivery.

All versions are DVGW-tested.

Approx. dimensions: hose 2.5 m long.

1/2" union nut, 1/2" hose

1  white Item-No. 3222

2  silver Item-No. 3222-02

3/4" union nut, 3/4" hose

3  white Item-No. 3224

4  black Item-No. 3224-01

5  silver Item-No. 3224-02

1" union nut, 3/4" hose

6  white Item-No. 3221

7  black Item-No. 3221-01

8  silver Item-No. 3221-02

Kneipp Hose with adjustable jet nozzle, without wall holder

Spot to sieve jet infinitely adjustable. Union nut, adjustable jet nozzle, double-walled, food-safe. With all connecting parts made of stainless steel.

Jet nozzle fits exactly into solid metal wall holder, item-no. 3227. Not included in delivery.

All versions are DVGW-tested.

Approx. dimensions: hose 2.5 m long.

3/4" union nut, 3/4" hose

9  white Item-No. 3223

10  black Item-No. 3223-01

11  silver Item-No. 3223-02



item description	color	item number	unit price	from 3 pieces	from 10 pieces	from 25 pieces	from 50 pieces
1 Kneipp Hose 1/2", without wall holder	white	3222					
2	silver	3222-02					
3	white	3224					
4 Kneipp Hose 3/4", without wall holder	black	3224-01					
5	silver	3224-02					
6	white	3221					
7 Kneipp Hose 1", without wall holder	black	3221-01					
8	silver	3221-02					
9	white	3223					
10 Kneipp Hose 3/4", with jet nozzle, without wall holder	black	3223-01					
11	silver	3223-02					

All prices apply only to industry, trade, craft and commerce and are subject to VAT ex warehouse. No minimum quantity surcharge.



Shower Hose with rubber protection ring, without wall holder

The shower hose gives a soft, pleasant jet. The risk of injury and tile breakage is considerably minimised by the rubber protection ring.

Union nut. Connecting parts made of stainless steel. All versions are DVGW-tested.

Approx. dimensions: hose 2.5 m long.

¾" union nut, ¾" hose

1		white	Item-No. 3232
2		black	Item-No. 3232-01
3		silver	Item-No. 3232-02

Hose double walled, food-safe

All versions are DVGW-tested.

½", product sold by meter

4		white	Item-No. 3292-1
5		silver	Item-No. 3292-5

¾", product sold by meter

6		white	Item-No. 3292-2
7		black	Item-No. 3292-4
8		silver	Item-No. 3292-6

Full Metal Wall Holder made of stainless steel for Kneipp hoses

Suitable for the Kneipp hoses described before. The metal outlet sleeve of the Kneipp hoses fits perfectly into the wall holder.

For ½" hose with connection

9		stainless steel	Item-No. 3229
---	--	-----------------	---------------

For ¾" hose with connection

10		stainless steel	Item-No. 3227
----	--	-----------------	---------------



Please note that all our Kneipp hoses are cold water hoses.

item description	color/size	item number	unit price	from 3 pieces	from 10 pieces	from 25 pieces	from 50 pieces
1 Shower Hose with rubber protection ring, without wall holder	white	3232					
	black	3232-01					
	silver	3232-02					
4 Hose ½", product sold by meter	white	3292-1					
	silver	3292-5					
6 Hose ¾", product sold by meter	white	3292-2					
	black	3292-4					
	silver	3292-6					
9 Full Metal Wall Holder, stainless steel	for ½"	3229					
	for ¾"	3227					

All prices apply only to industry, trade, craft and commerce and are subject to VAT ex warehouse. No minimum quantity surcharge.

Full-Metal Wall Valve heavy duty version

With backflow preventer. Stainless steel valve seat and metal handle.

3/4" wall socket,
3/4" hose connection thread

1  Item-No. 3265

1/2" wall socket,
3/4" hose connection thread

2  Item-No. 3266

1/2" wall socket,
1/2" hose connection thread

3  Item-No. 3267

Wall Connection Bracket full metal

Universal wall connection bracket with 1/2" or 3/4" wall connection and 3/4" hose connection thread.

Double nipple for 1/2" or 3/4" wall connection included.

4  reflux-proof Item-No. 3260

1/2" wall connection with 1/2" hose connection thread.

5  reflux-proof Item-No. 3262

Combi Wall Holder wall connection + wall holder

With 3/4" wall connection, 3/4" hose connection thread and 3/4" wall holder for hose, chrome-plated.

6  Item-No. 3228



item description	connection	item number	unit price	from 3 pieces	from 10 pieces	from 25 pieces	from 50 pieces
1 Full-Metal Wall Valve	3/4" - 3/4"	3265					
2	3/4" - 1/2"	3266					
3	1/2" - 1/2"	3267					
4 Wall Connection Bracket	3/4" - 3/4" / 1/2"	3260					
5	1/2" - 1/2"	3262					
6 Combi Wall Holder	3/4" - 3/4"	3228					

All prices apply only to industry, trade, craft and commerce and are subject to VAT ex warehouse. No minimum quantity surcharge.



Vitality Dousing Shower with ball joint

Particularly mobile due to swivelling ball joint. Solid cast brass design. Long service life without maintenance.

1 1/2" connection Item-No. 3210

2 3/4" connection Item-No. 3211

3 1" connection Item-No. 3212

liters/min at pressure (bar)	Item-No.					
	1	1.5	2	2.5	3	
1/2"	3210	13	40	77	89	96
3/4"	3211	110	120	124	130	135
1"	3212	115	125	131	138	145

dimensions (for sketch)	A mm	B mm	T mm	kg netto	
1/2"	3210	120	88	80	0.6
3/4"	3211	150	142	80	1.6
1"	3212	152	142	80	1.7

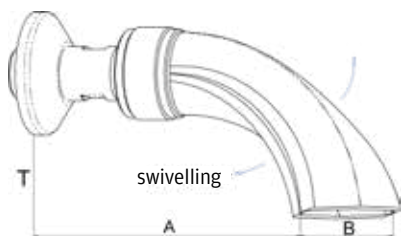

Power Dousing Shower

Heavy duty version. Suitable for commercial wellness areas. In an elegantly curved shape for optimised jet formation.

With firmly connected, smooth brass pipe \varnothing 5 cm, Threaded connection L 5 cm without ball joint with solid thrust rosette \varnothing 7.3 cm - height 1.5 cm. Connection pipe 1 1/4".

Approx. dimensions: L x B x H: 20 x 14.2 x 8 cm.

4 Item-No. 3213

item description	item number	unit price	from 3 pieces	from 10 pieces	from 25 pieces	from 50 pieces
1 Vitality Dousing Shower	1/2" connect. 3210					
2 Vitality Dousing Shower	3/4" connect. 3211					
3 Vitality Dousing Shower	1" connect. 3212					
4 Power Dousing Shower	3213					

All prices apply only to industry, trade, craft and commerce and are subject to VAT ex warehouse. No minimum quantity surcharge.

Rain showers that are fun!

Like a gentle summer rain:

KNAUSS rain rain shower

Do you know the feeling when you unexpectedly get caught in a light shower on a hot summer day? KNAUSS rain gives you this benefit every day.

KNAUSS rain Rain Shower Head complete with ceiling arm

With ½" ball joint connection, monsoon effect with particularly soft rain flow, solid chrome-plated brass.

Plate shape with anti-limescale plastic nozzles.

Approx. dim.: 10 cm long, ø 20 cm.



Item-No. 3275

KNAUSS rain Rain Shower Head complete with wall arm

as above, but with wall arm.

Approx. dim.: 30 cm long, ø 20 cm.



Item-No. 3277

KNAUSS rain Rain Shower Head

as above, but only shower head.

Approx. dimensions: ø 20 cm.



Item-No. 3272-2



item description	item number	unit price	from 3 pieces	from 10 pieces	from 25 pieces	from 50 pieces
1 ceiling arm	3275					
2 KNAUSS rain Rain Shower, plate shape	wall arm	3277				
3 shower head	3272-2					

All prices apply only to industry, trade, craft and commerce and are subject to VAT ex warehouse. No minimum quantity surcharge.

The jet
makes vital
- with monsoon
effect

KNAUSS pro Overhead Shower

With 1/2" union nut with anti-limescale system and 3 different jet options, made of chrome-plated plastic. With plastic nozzles.

Approx. dimensions: \varnothing 8 cm.



Item-No. 3278



KNAUSS rain Shower Arm ceiling mounting

Brass version, chrome-plated with threaded spigot length 4 cm and rosette \varnothing 6,5 cm.

for ceiling mounting 1/2" x 1/2"



10 cm long

Item-No. 3285



30 cm long

Item-No. 3287



KNAUSS rain Shower Arm wall mounting

as above, but wall mounting.

for wall mounting 1/2" x 1/2"



30 cm long

Item-No. 3282



45 cm long

Item-No. 3288



item description	size	item number	unit price	from 3 pieces	from 10 pieces	from 25 pieces	from 50 pieces
1 KNAUSS pro Overhead Shower	\varnothing 8 cm	3278					
2 KNAUSS rain Shower Arm, for ceiling mounting	L 10 cm	3285					
3 KNAUSS rain Shower Arm, for ceiling mounting	L 30 cm	3287					
4 KNAUSS rain Shower Arm, for wall mounting	L 30 cm	3282					
5 KNAUSS rain Shower Arm, for wall mounting	L 45 cm	3288					

All prices apply only to industry, trade, craft and commerce and are subject to VAT ex warehouse. No minimum quantity surcharge.



Bucket Surge Shower

Water connection via shower hose or hose screw connection. Connection to 3/8" or 1/2" external thread possible from the left or right (hose not included).

- Good dosing with low tractive force
- Water content adjustable at the filling valve (5.5 - 15 l)
- 3 stainless steel hoops, large 29 l bucket made of Kambala
- strong white pull rope made of PES cordage
- incl. complete mounting device made of V2A-stainless steel and float valve
- can be mounted on wall or ceiling

Apr. dim.: bucket Ø top 41 cm, H 31.5 cm, distance flush approx. 50 cm. total weight approx. 12 kg.

Interior Version

Bucket with transparent hygienic seal.

1 Item-No. 8920

Exterior Version V2A

Bucket coated with weather protection glaze on outside, blue on inside. Mounting device made of V2A stainless steel.

2 Item-No. 8921

Exterior Version V4A

Bucket coated with weather protection glaze on outside, blue on inside. Mounting device made of V4A stainless steel. Resilient.

3 Item-No. 8922

Spare Parts for Bucket Surge Shower

Individual spare parts for the bucket surge shower.

4	Bucket, interior version	Item-No. 8960
5	Bucket, exterior version	Item-No. 8961
6	Mounting with Swivel Axis, V2A	Item-No. 8964
7	Mounting with Swivel Axis, V4A	Item-No. 8965
8	Float Valve	Item-No. 8962
9	Rope, made of PES cordage	Item-No. 8963



item description	version	item number	unit price	from 3 pieces	from 10 pieces	from 25 pieces	from 50 pieces
1 Bucket Surge Shower, complete	interior	8920					
2	exterior V2A	8921					
3	exterior V4A	8922					
4 Spare Bucket for Bucket Surge Shower	interior	8960					
5	exterior	8961					
6 Spare Mounting with Swivel Axis for Bucket Surge Shower	V2A	8964					
7	V4A	8965					
8 Spare Float Valve for Bucket Surge Shower		8962					
9 Spare Rope for Bucket Surge Shower		8963					

All prices apply only to industry, trade, craft and commerce and are subject to VAT ex warehouse. No minimum quantity surcharge.

Color code for the correct cloth application



WC, urinal basin



Washbasin, mirror, tiles



Furniture



Surfaces in the kitchen area

Microfibre Cloth

With abrasive cleaning strips. Bristles loosen stubborn dirt, soft fibres absorb water and loosened dirt. The reverse side is suitable for wiping and for sensitive surfaces.

Approx. dimensions: 40 × 40 cm, weight: 68 g, Washable up to 90 °C, suitable for tumble dryer.

1	★ red	Item-No. 3460-1
2	★ yellow	Item-No. 3460-2
3	★ blue	Item-No. 3460-3
4	★ green	Item-No. 3460-4

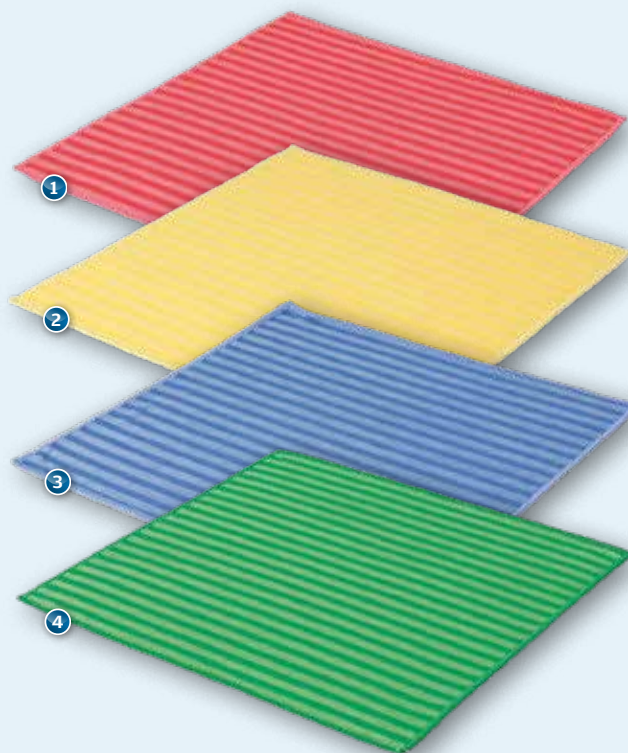

Copper + Cleaning Cloth with copper pigments

Developed together with the University of Innsbruck and consisting of microfibres refined with copper pigments. Removes dirt, viruses and bacteria from smooth surfaces simply by wiping with water.

Over 99.9 % of the viruses/bacteria absorbed are retained in the cloth and inactivated within a short time. Reduces the risk of spreading germs.

Approx. dimensions: 32 × 32 cm.

5	PU 1 piece	Item-No. 9230
---	------------	---------------



Disposable Overshoes

Extra strong, hammered, with elastic, color blue.

6	PU 100 pieces	Item-No. 3485
---	---------------	---------------



item description	color/PU	item number	unit price	from 3 pieces	from 10 pieces	from 25 pieces	from 50 pieces
1 2 3 4 Microfibre Cloth	red	3460-1					
	yellow	3460-2					
	blue	3460-3					
	green	3460-4					
5 Copper + Cleaning Cloth	PU 1 piece	9230					
6 Disposable Overshoes	PU 100 pcs.	3485					

All prices apply only to industry, trade, craft and commerce and are subject to VAT ex warehouse. No minimum quantity surcharge.



Lahti OULUJÄRVI Sauna Protection & Care Product

safe, healthy and eco-friendly

OULUJÄRVI is a pure natural product on organic basis whose regular use makes your sauna look like new longer. Annoying moisture deposits on sauna benches are now a thing of the past.

- Suitable for all wooden surfaces in the sauna and wellness area
- Permanently prevents moisture buildup and staining
- Made on a natural basis, dermatologically safe and heat resistant

1 liter sufficient for the treatment of 10 m² of bench surface (2 operations).

- ① 500 ml Item-No. 3880
- ② 5 liter (w/o illust.) Item-No. 3881

Lahti PURUVESI Sauna Basic Cleaner

PURUVESI is a sauna wood cleaner for sauna benches and other untreated wooden surfaces. Cleaned surfaces are optimally prepared for subsequent post-treatment with OULUJÄRVI.

- Suitable for all wooden surfaces in the sauna and wellness area
- Made on a natural basis
- 100% organic, vegan, odorless
- Without pollutants and solvents

1 liter sufficient for a bench surface of about 20 m² (1 operation).

- ③ NEW 500 ml Item-No. 3882
- ④ NEW 5 liter (w/o ill.) Item-No. 3883

Lahti TAAJUUS Sauna Maintenance Cleaner

TAAJUUS is a maintenance cleaner for once or twice weekly care of sauna benches and other untreated wooden surfaces.

- Suitable for all wooden surfaces in the sauna and wellness area
- Made on a natural basis
- 100% organic, vegan, odorless
- Without pollutants and solvents

1 liter sufficient for a bench surface of about 40 m².

- ⑤ NEW 500 ml Item-No. 3884
- ⑥ NEW 5 liter (w/o ill.) Item-No. 3885

item description	container size	item number	fixed price
① Lahti OULUJÄRVI Sauna Wood Protection & Care Product	500 ml	3880	
②	5 liter	3881	
③ Lahti PURUVESI Sauna Wood Basic Cleaner	500 ml	3882	
④	5 liter	3883	
⑤ Lahti TAAJUUS Sauna Wood Maintenance Cleaner	500 ml	3884	
⑥	5 liter	3885	

All prices apply only to industry, trade, craft and commerce and are subject to VAT ex warehouse. No minimum quantity surcharge.

The Best for the sauna

With products from Lahti, your sauna and wellness facility will stay fresh and clean longer as on the first day.

These are also good for the environment: Lahti products are biologically based, dermatologically safe and do not evaporate - even under high sauna temperatures.



Lahti Sauna Care Set for perfect protection & easy cleaning

This care set especially for sauna woods guarantees the protection and cleaning of your sauna. Supplemented by appropriate accessories, you can clean and protect all natural wood indoors from dirt with this "carefree package".

- 1 × 500 ml Lahti PURUVESI basic cleaner
- 1 × 500 ml Lahti OULUJÄRVI protection & care
- 1 × Grinding sponge
- 1 × Cleaning cloth
- 1 × Processing sponge
- 1 pair of gloves and care instructions

1 NEW Sauna Care Set in carton Item-No. 3889-1

Lahti Sauna Pure Set for regular cleaning & disinfection

This set especially for sauna woods guarantees gentle cleaning and disinfection of your sauna. Supplemented by appropriate accessories, you can use this complete solution to clean and disinfect all natural wood indoors.

- 1 × 500 ml Lahti TAAJUUS maintenance cleaner
- 1 × 500 ml Lahti HYGIENIA PRO disinfectant
- 1 × Special cleaning sponge
- 1 × Cleaning cloth
- 1 pair of gloves and care instructions

2 NEW Sauna Pure Set in carton Item-No. 3889-2

	item description	item number	fixed price
1	Lahti Sauna Care Set	3889-1	
2	Lahti Sauna Pure Set	3889-2	

All prices apply only to industry, trade, craft and commerce and are subject to VAT ex warehouse. No minimum quantity surcharge.

Which Product for your application area?

With the adjacent table you can find out which of our cleaning and disinfecting agents is the right one for you.



pH value acidic
e. g. lime, cement film, rust film



pH value neutral
sensitive surfaces e. g. marble



pH value alkaline
e. g. grease, soap-residues, coating agents



Disinfectants and Cleaning Agents

FINNSA All-Purpose Cleaner Item-No. 3430	concentrate	grease, oil, heavy dirt on alkali-resistant surfaces	very strong, powerhouse, alkaline
Desonal Surface Disinfectant Item-No. 3410/3416	concentrate	disinfects and cleans water-resistant surfaces	neutral, mild, VAH-compliant

Disinfectants

Desonal Rapid Disinfectant Item-No. 3490/3492	ready-to-use	disinfects very compatible with materials, especially wood	against corona viruses, bacteria, fungi, long-term effect, VAH-compliant
Desonal Hand Disinfectant RKI Item-No. 3459	ready-to-use	well suited for allergy sufferers, as without other additives	particularly strong against viruses (also Corona), alcohol, Official RKI formulation, VAH-compliant

Special Cleaning Agents

FINNSA Sanitary Cleaner Item-No. 3452	concentrate and ready-to-use	limescale stains on tiles and sanitary installations, rust, incrustations	very strongly acidic, free of hydrochloric acid, thickened
Uni Speed Plastic Cleaner Item-No. 3441/3443	ready-to-use	clean plastic couches, furniture & covers with the microfibre cloth	fast, simple, productive
FINNSA Sauna Des Item-No. 3420/3421	ready-to-use	environmentally friendly wood bleaching, stain removal	bleaches without changing the wood structure, decomposes to water and oxygen, no residues

Cleaning Agents

Sauna Cleaning Agent Item-No. 3458	concentrate	Cleans all washable and water-resistant surfaces	Very economical, glossy result, quick-drying
---------------------------------------	-------------	--	--

Sauna Cleaning Agent

ideal surface cleaner

Very mild material-compatible cleaner for streak-free cleaning of all water-resistant surfaces, e.g. wood, plastic, metal and ceramics.

Does not contain any ingredients that form layers. Dries without streaks. Alcohol ensures rapid drying.

Application: Damp/wet wipe method with a lint-free cloth or mop. Always use diluted.

1 1 liter Item-No. 3458

Dosing Device

Suitable for 1 liter bottles.
For dosages from 5 to 20 ml.

2 Item-No. 3495



Outlet Tap

Suitable for 10 liter canisters.

3 Item-No. 3496-2



item description	container size	item number	unit price	from 3 pieces	from 10 pieces	from 25 pieces	from 50 pieces
1 Sauna Cleaning Agent	1 liter	3458					
2 Dosing Device		3495					
3 Outlet Tap		3496-2					

All prices apply only to industry, trade, craft and commerce and are subject to VAT ex warehouse. No minimum quantity surcharge.



FINNSA All-Purpose Cleaner

disinfecting, biocidal and fungicidal properties

For the maintenance cleaning of sanitary facilities, changing rooms and shower and wash cubicles.

Grease, oil and soap deposits are quickly and reliably removed from all alkali- and water-resistant surfaces. Also effective against corona viruses. Also suitable for use in high-pressure cleaners.

Application: Dilute and apply manually with sponge/cloth. Allow to act for 10 min., rinse with water.

BAuA registration number N-44405

①  1 liter

Item-No. 3430

disinfection
and cleaning
agents

Desonal Surface Disinfectant

disinfection and cleaning

Suitable for all water-resistant surfaces. Can be used e.g. in leisure pools, gyms and hotels. Free of aldehydes and alcohols. VAH-compliant.

Effective against bacteria, viruses, yeasts, fungi, salmonellae, hepatitis B pathogens and coronaviruses.

Application: Dilute, apply with mop/cloth, leave to act, rinse with plenty of water and dry.

BAuA registration number N-44375

②  1 liter

Item-No. 3410

③  10 liters (without illustration)

Item-No. 3416

disinfectants

Desonal Rapid Disinfectant

immediately ready for use

Liquid broad-spectrum disinfectant for saunas, solariums, fitness equipment. Also suitable for spray disinfection.

Effective against bacteria, fungi, viruses, yeasts, MRSA, HIV, rotaviruses, hepatitis B, E.Coli, noroviruses, influenza (H1N1) and coronaviruses.

Application: Apply undiluted with cloth/mop cover and leave to act for 1 min. (30 min. for noroviruses). Wipe thoroughly with a damp cloth, rinse and dry.

BAuA registration number N-44374

④  500 ml

Item-No. 3490

⑤  10 liters (without illustration)

Item-No. 3492

	item description	container size	item number	unit price	from 3 pieces	from 10 pieces	from 25 pieces	from 50 pieces
①	FINNSA All-Purpose Cleaner	1 liter	3430					
②	Desonal Surface Disinfectant and Cleaner	1 liter	3410					
③		10 liters	3416					
④	Desonal Rapid Disinfectant	500 ml	3490					
⑤		10 liters	3492					

All prices apply only to industry, trade, craft and commerce and are subject to VAT ex warehouse. No minimum quantity surcharge.

For special Cleaning

FINNSA Sanitary Cleaner dissolves limescale & other deposits

For basic and maintenance cleaning of heavily soiled, acid-resistant sanitary facilities. Not for light metals, galvanised sheet metal, marble, enamel, limestone.

Check material compatibility before use! Do not use undiluted on fittings. Particularly low-odour.

Application: Pre-water the surface, apply with suitable equipment, allow to react, rinse with water.

②  1 liter Item-No. 3452

Uni Speed Plastic Cleaner ready for use

Optimal for the quick and thorough cleaning of plastic couches and covers. Also for all smooth surfaces such as stainless steel, handrails, doors, etc.

Application: Apply a few drops/sprays to the surface. Remove dirt such as nicotine and grease residues with a microfibre cloth.

③  500 ml Item-No. 3441

④  10 liter (without illustration) Item-No. 3443



Request DIN safety data sheets by email to info@finnsa.de. All agents are listed or approved according to German regulations.

Use biocidal products with care. Read label and product information before use.

All cleaners are not suitable for internet sales to private customers. Only for trade and specialised trade!

Desonal Hand Disinfectant RKI

Hand disinfection with short contact time for all areas of human hygiene with high demands on hand hygiene. Particularly suitable for allergy-sensitive persons.

Ready-to-use alcoholic solution without added fragrances/other chemical additives.

Bactericidal, fungicidal, virucidal effective. Against HIV, influenza, noro-, corona- and adenoviruses.

Application: Pour into palm and immediately rub intensively with both hands for at least 30 seconds.

BAuA registration number N-95761

①  1 liter

Item-No. 3459

disinfectants

special
cleaning
agent



FINNSA Sauna Des bleaching, for the sauna area

Especially for saunas to brighten benches, wooden walls and headrests. Free of aldehydes and alcohols.

Application: Apply undiluted to wood surface. Rinse off after apr. 10 min. Check result. Repeat if necessary.

⑤  2 liter (without illustration) Item-No. 3420

⑥  10 liters Item-No. 3421

	item description	container size	item number	unit price	from 3 pieces	from 10 pieces	from 25 pieces	from 50 pieces
①	Desonal Hand Disinfectant RKI	1 liter	3459					
②	FINNSA Sanitary Cleaner	1 liter	3452					
③	Uni Speed Plastic Cleaner	500 ml	3441					
④		10 liters	3443					
⑤	FINNSA Sauna Des	2 liters	3420					
⑥		10 liters	3421					

All prices apply only to industry, trade, craft and commerce and are subject to VAT ex warehouse. No minimum quantity surcharge.

sitting
clean and hygienic
 everywhere



Steam Bath Seating Pads

Space-saving, inexpensive, hygienic. Can be used as a disposable pad or washed at 60 °C.

Material: Polypropylene PP, white
 Apr. dim.: 53 × 40 cm, approx. 50 g.

①  PU 100 pieces Item-No. 4810

Reusable Steam Bath Seating Pad

Hygienic underlay for all bathing forms. Seat side: short towelling coating. Underside: waterproof PVC layer.

Washable at 60 °C, heat insulated.
 Approx. dimensions: 35 × 45 cm.

②  white, PU 1 piece Item-No. 7730

③  blue, PU 1 piece Item-No. 7731

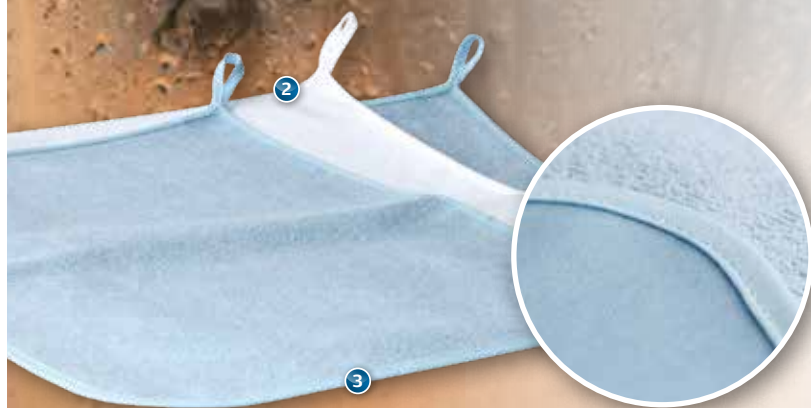

item description	color	item number	unit price	from 3 pieces	from 10 pieces	from 25 pieces	from 50 pieces
① Steam Bath Seating Pads, PU 100 pieces	white	4810					
② Reusable Steam Bath Seating Pad, PU 1 piece	white	7730					
③	blue	7731					

All prices apply only to industry, trade, craft and commerce and are subject to VAT ex warehouse. No minimum quantity surcharge.

Foot Tub "Larch" standard, including insert

Made of untreated larch wood, bound with metal hoops. With 2 extended handle hoods. Including plastic insert item. no. 8990.

Apr. dim.: H 20 cm, stave handles H 29 cm, Ø top 40 cm, Ø bottom 35 cm.

1  16l  Item-No. 8928-1

as above, but sealed transparent inside and outside and without insert.

Apr. dim.: H 20 cm, stave handles H 30 cm, Ø top 40 cm, Ø bottom 35 cm.

2  16l  Item-No. 8926

Plastic Insert

Lye-resistant plastic insert. Suitable for tubs 8925, 8926 and 8928-1.

3  16l  Item-No. 8990

Foot Tub "Kambala" transparently hygiene-sealed



Made of kambala wood. Inside and outside transparent hygiene sealed. Bound with two metal hoops. With 2 extended staves.

Apr. dim.: H 20 cm, stave handles H 30 cm, Ø top 40 cm, Ø bottom 35 cm.

4  16l  Item-No. 8925



as above, but with feet, chromed brass stand-pipe and drain.

Apr. dim.: H 23 cm, stave handles H 33 cm, inner height 17 cm, Ø top 40 cm.

5  16l  with drain Item-No. 8930

as above, but with feet, stainless steel stand-pipe and drain.

Apr. dim.: H 35 cm, Ø top 42 cm, Ø bottom 35 cm, without stave handles.

6  29l  high, w/ drain Item-No. 8935



Kambala wood has a uniform fine texture, is very resistant to pressure and extremely resistant. The grain and texture of the lighter **larch wood** is more vivid and contrasting.

item description	capacity	item number	unit price	from 3 pieces	from 10 pieces	from 25 pieces	from 50 pieces
1 Foot Tub "Larch", incl. insert	16 liters	8928-1					
2 Foot Tub "Larch", sealed	16 liters	8926					
3 Plastic Insert for Foot Tubs	16 liters	8990					
4 Foot Tub "Kambala", sealed	16 liters	8925					
5 Foot Tub "Kambala", sealed + drain	16 liters	8930					
6 Foot Tub "Kambala", sealed, high + drain	29 liters	8935					

All prices apply only to industry, trade, craft and commerce and are subject to VAT ex warehouse. No minimum quantity surcharge.

Foot basin

FINNSA Cast Mineral Foot Basin

High-quality and extremely stable composite material made from approx. 80 % natural minerals such as marble powder or quartz sand. Bonded with resins. Coated with a coloring polyester resin layer.

- High-gloss, hygienic and non-porous surface
- Easy-care, hard-wearing and skin-friendly
- Long service life

Delivery includes standpipe valve (chrome-plated), valve base and siphon.

Special colors and effect colors available on request.

Apr. dim.: see sketch, request a data sheet. Weight: apr. 20 kg.

1  white

Item-No. 0920

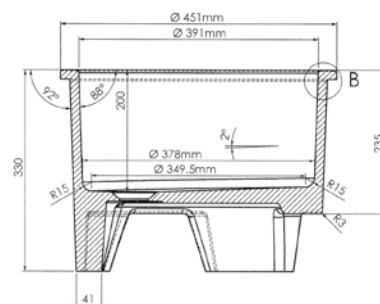

item description

color

item number

unit price

from 3 pieces

from 10 pieces

from 25 pieces

from 50 pieces

1

FINNSA Cast Mineral Basin

white

0920

All prices apply only to industry, trade, craft and commerce and are subject to VAT ex warehouse. No minimum quantity surcharge.



Info

All plunge pools are cleanly planed and sanded. Waterproof glued with tongue and groove. Strapped with 3 hot-dip galvanised tyres incl. inner step and water drain with stainless steel standpipe as overflow protection. Incl. outer ladder for hanging. The transparent hygienic seal is not UV-resistant.

Our products are handmade.

Delivery time approx. 2 months

Plunge Pool

Sauna Plunge Pool "Larch"

Flamed on the outside, blue hygienic seal on the inside, almost impermeable to moisture. Not suitable for outdoor use.

Approx. dim.: L × W × H: 100 × 72 × 100 cm.
Capacity apr. 336 l at 70 cm water level height.

1  Item-No. **8910**

as above, but inside and outside transparent hygienic seal.

2  without illustration Item-No. **8911**



item description	capacity	item number	unit price	from 3 pieces	from 10 pieces	from 25 pieces	from 50 pieces
1 Plunge Pool "Larch", blue seal	336 liters	8910					
2 Plunge Pool "Larch", transparent seal	336 liters	8911					

All prices apply only to industry, trade, craft and commerce and are subject to VAT ex warehouse. No minimum quantity surcharge.



Sauna Plunge Pool "Kambala"

Made of Kambala wood, transparent hygienic seal inside and out. Almost impermeable to moisture. Not suitable for outdoor use.

Apr. dim.: L × W × H: 110 × 77 × 100 cm, oval.
capacity apr. 406 l at 70 cm water level height.



Item-No. 8940

Apr. dim.: L × W × H: 130 × 79 × 100 cm, oval.
capacity apr. 483 l at 70 cm water level height.



without illustration

Item-No. 8945

	item description	capacity	item number	unit price	from 3 pieces	from 10 pieces	from 25 pieces	from 50 pieces
1	Plunge Pool "Kambala", transparent seal	406 liters	8940					
2		483 liters	8945					

All prices apply only to industry, trade, craft and commerce and are subject to VAT ex warehouse. No minimum quantity surcharge.

General Terms and Conditions of Sale

of the company Finnsa GmbH, D-36304 Alsfeld

1. General

Unless otherwise agreed, the following terms and conditions shall apply exclusively to all purchase contracts and our offers. The customer's general terms and conditions shall not apply, even if we do not expressly object to them.

We reserve the right to make technical changes, dimensions and optical deviations insofar as these are not disadvantageous and reasonable for the customer. Color reproductions are approximate values. Errors and all rights reserved.

In the case of individual or customised products, special colors/sizes, imprinted names, etc., goods cannot be returned. Quantity differences of up to +/- 10 % may occur in the case of custom-made products.

No liability can be accepted for any printing errors. Product photos can deviate from the original product, labels of our products can change at any time. Our products or their labels may also be updated or revised at any time. Batteries are generally not included in the scope of delivery.

2. Orders

Shall be deemed accepted by us when confirmed in writing. Offers are always subject to change and valid for 6 weeks from the date of the offer, unless otherwise stated.

3. Prices

Unless otherwise agreed in writing, prices are ex warehouse Alsfeld (Hesse, Germany) or factory warehouse, plus packaging and transport costs, plus statutory VAT. Transport insurance is not included in the price. Unless otherwise agreed in writing, payment shall be made at our discretion: Within 14 days of the invoice date, net. Direct debit immediately upon invoicing minus 2% discount. We reserve the right to process orders by prepayment if necessary. In case of direct shipment to your customers plus 3,50 € handling fee. The prices of the current price list valid on the day of invoicing apply.

4. Retention of title

The delivered goods remain our property until full payment of all claims arising from the business relationship, including deposits of bank collections, and may not be resold until then.

5. Delivery times

These are always non-binding. Operational disruptions at our company, our suppliers and carriers, or special events of force majeure extend the stated delivery times by the time loss caused by the events. Partial deliveries in due time and quantity are permissible and can be invoiced separately.

6. Warranty

We provide a warranty on the delivered goods for one year from the date of invoice. The prerequisite is proper handling. Illuminants and wear parts are excluded from this warranty. A replacement will be provided for defects that occur within the warranty period and are due to material defects. Further claims will not be accepted.

7. Damages in transit

Will only be accepted by us under the conditions listed below: Inspect all consignments immediately on arrival for transport damage so that claims for compensation against third parties are secured. It is absolutely necessary to call in representatives of the transport company in good time to ascertain the damage. In the case of externally visible damage or loss, you must request that the damage be recorded and that a statement of the facts be handed over before accepting the goods. In the case of postal consignments, the damage must be certified in writing by the post office before damaged parcels etc. are accepted. In the case of damage which is not visible from the outside, i.e. which only becomes apparent when the goods are unpacked, the goods must be left in the condition in which they were found and the carrier must be requested to ascertain the damage without delay. Be sure to keep the packaging.

Please comply with the deadlines for requesting the carrier to assess the damage, as otherwise the carrier's liability will lapse and we will not be able to provide free replacement deliveries. The deadlines in Germany are: for postal consignments: 24 hours after receipt of the consignment, for rail

transport: 7 days after receipt of the consignment, for motor vehicle transport: 4 days after receipt of the consignment.

However, we strongly recommend that you notify us immediately. Damage claims must also be reported to us in writing within 7 days after acceptance of the goods.

8. Data storage

We would like to inform you that we will only store and process your data by computer as far as this is necessary for business purposes and within the framework of the current GDPR (European Data Protection Regulation). Questions and requests for information on the subject of data protection can be directed to us at any time.

9. General liability

Claims for damages of any kind against us are excluded, unless there is gross negligence or intent, or the breach of an essential contractual obligation.

10. Place of fulfilment

The place of fulfilment and jurisdiction for both parties shall always be Alsfeld (Hesse, Germany) and the courts having jurisdiction by way of instance. Alsfeld shall be deemed to be agreed as the local competent court, also for dunning proceedings, and binding for both parties.

As of November 2023

We cannot guarantee the availability of all items over the entire period of validity of the catalog.

Copyright 2023 by
Finnsa GmbH, 36304 Alsfeld, Germany

Copyright product pictures: Finnsa GmbH

The image rights of some photos are held by Fotolia.de or Adobe Stock

We would also like to thank the Erlenbad Alsfeld for the kind support in taking many of our photos by the PR agency Marlik – Anja Kierblewski and also Tropical Islands for providing photos of our products.

All contents of this publication (texts, images, logos, etc.) are the property of Finnsa GmbH or have been made available to us for this catalog by third parties. This publication, images or parts thereof may not be reproduced, reprinted or stored without the written permission of Finnsa GmbH. The content is not legally binding. We expressly reserve the right to make changes. With the publication of this catalog, all previous catalogs become invalid.

Our offers apply to industry, trade, crafts and commerce.

Impressum

Address: Finnsa GmbH
Marburger Straße 35
36304 Alsfeld, Germany

VAT identification no.: DE 112607206

Phone: +49(0) 66 31 - 96 88 - 0

Fax: +49(0) 66 31 - 96 88 - 96

E-mail: info@finnsa.de

Homepage: www.finnsa.de

Commercial register: HRB 5003 - local court Gießen

Managing Director: Uwe Helm



Data protection information according to Art. 13 GDPR

of the company Finnsa GmbH, D-36304 Alsfeld

This data protection information informs you about the processing of your data at Finnsa GmbH Alsfeld, Marburger Straße 35, 36304 Alsfeld. According to Art. 4 No. 1 GDPR, your data includes all information that relates or can be related to your person, in particular by means of assignment to an identifier such as a name or to an organizational or personnel number with which your person can be identified.

Personal information and personal data

During your contractual relationship, Finnsa GmbH collects and processes information (both in paper format and in digital form).

These data include:

- Master data (name, address)
- Contract data (type of contract, start/end of contract)
- Business contact and communication data
- Authorizations (access rights, access rights to IT systems and data processing procedures, log data on the use of communication and data processing systems, recordings from the video surveillance system)
- History data
- Bank details

Purposes of collection and processing

Finnsa GmbH collects, processes and uses your personal data exclusively for the purposes of the contractual relationship and for business purposes permitted within the scope of our business activities. These include:

- Internal administrative and organizational purposes
- Ensuring the security and protection of processing procedures and data from unauthorized access, falsification and use
- Protect the company's facilities, equipment, and assets from theft and other damage

Your data will only be processed for purposes other than those stated if such processing is compatible with the purposes of the employment relationship. We will inform you about such processing before further processing of your data and, if necessary, obtain your consent.

Your data protection rights

Your data protection rights are regulated in Chapter III (Art. 12 ff.) of the European Data Protection Regulation (GDPR). According to these regulations, you have a right to information about the personal data stored about you, about the purposes of processing, about any transfers to other bodies and about the duration of storage.

To exercise your right to information, you can also obtain extracts or copies. If data is incorrect or no longer required for the purposes for which it was collected, you may request that it be corrected, deleted or restricted from processing. Where provided for in the processing procedures, you may also inspect your data yourself and correct it if necessary.

If your particular personal situation gives rise to reasons against the processing of your personal data, you may object to processing insofar as the processing is based on a legitimate interest. In such a case, we will only process your data if there are special compelling interests for this.

If you have any questions about your rights and how to exercise them, please contact your HR department or the company data protection officer.

Legal basis for the processing of your personal data

The legal basis for the processing of your personal data for purposes of the contractual relationship is Art. 6 para. 1 lit. b) and lit. c) GDPR.

Data is only collected and processed for this purpose if this is required by law or in accordance with the employment contract. Insofar as further data may not be directly required for the implementation of the employment relationship, the processing is based on a legitimate interest of the company pursuant to Art. 6 (1) lit. f) GDPR.

A legitimate interest may arise, for example, from internal organizational and administrative purposes, to protect the company's facilities, equipment and assets, as well as data processing equipment and data. Processing of your data is permissible here if the protection of your interests, fundamental rights and freedoms does not prevail.

In individual cases, we may also obtain your consent to the processing or transmission of your data. In these cases, your consent is voluntary and can be revoked by you for the future at any time, unless otherwise agreed. You will not suffer any disadvantages from a non-consent or a possible later revocation of a consent.

Transmission of your personal information

Your personal data will only be transferred or disclosed to external bodies insofar as this is required by a legal norm or necessary for the fulfillment of the employment contract concluded with you (e.g. to tax and social security authorities, banks, auditors), or on the part of Finnsa GmbH or an external body a legitimate interest in the above sense exists and the

transfer is permissible according to the data protection regulations.

Your personal data and information may also be disclosed by Finnsa GmbH to agents and contractors who provide a service for us, including insurers and consultants, for legitimate purposes, to the extent that permission to do so exists in individual cases in accordance with data protection regulations. If your consent or separate notification is required for this, we will obtain your consent beforehand or inform you in good time beforehand. Your personal data may also be transferred to service companies for the performance of data processing tasks, e.g. for the performance of automated personnel data processing or payroll accounting. In doing so, we will observe the data protection regulations.

Certain personnel administration and personnel management tasks are performed centrally by Finnsa GmbH. A data transfer or disclosure of your data will only take place to the extent necessary for this purpose and in compliance with the relevant data protection regulations. As far as a data transfer to third countries or a disclosure to bodies in third countries takes place, the additional requirements for this are observed. In accordance with these regulations, a contract required by the GDPR has been concluded between Finnsa GmbH and the processing entity in accordance with the EU standard contractual clauses.

Entity responsible for the processing of your personal data

The competent and responsible body for the collection, processing and use of your personal data is Finnsa GmbH in the Federal Republic of Germany, unless otherwise contractually agreed.

The personnel data is stored and processed in personnel data processing systems. The technical installation is designed in such a way that only a narrowly defined group of specially authorized persons is authorized to access the data and that any other access to or knowledge of the data is precluded in accordance with the state of the art.

Complaints about the processing of your personal data

If you have concerns or a question about the processing of your personal data and information, you can contact Finnsa GmbH. You can also contact the company data protection officer or the data protection supervisory authority using the contact details below.

Data Protection Office Rößner
Karl-Bröger-Str. 10, D-36304 Alsfeld
dsb@ra-roessner-merle.de

The Hessian Commissioner for Data Protection and Freedom of Information
P.O. Box 3163, D-65021 Wiesbaden
Phone: +49 611 1408 - 0, Fax: +49 611 1408 - 900 / 901

Duration of storage

Your personal data will only be stored as long as knowledge of the data is necessary for the purposes of the contractual relationship or the purposes for which it was collected, or as long as legal or contractual retention requirements exist.

Different statutory retention periods result from tax law, labor law and social security law regulations and extend up to ten years for documents and receipts relevant under tax law. After you leave our company, we will retain your personnel file for a period of 10 years.

As of November 2023

