



fragrances wedel ring sugar
buckets gongs sauna creams
bucket surge shower tables
wedel sails neck rolls fruits
fragrance concentrates salt
hygrometer head rests **lights**
mesh floor mat chair cushions
towel rails fragrance gel tins
steel loungers signs stools
hooks wristbands potpourri
illuminants locking elements
infusion balls foot tubs kilts
wet room clocks branches
bathing shoes scarf benches
dosing aids massage creams
thermometer scales net bags
surge showers kneipp hoses
massage oils twigs bathrobes
singing bowls rain showers
glasses rack **stones** menthol
pestemals brushes cushions
hourglasses ventilation grilles
disinfectants infusion fans
sauna hats herbs detergents
anteroom clocks wedel flags
seating pads sauna honey
sarongs locker room benches
floor grates plastic loungers
aluminium loungers blankets
foot basins cork hygiene mat
information material chairs
towels door handles ladles
hamam towels plunge pools
bowls supergrip hygiene mat
hair dryer hangers backrests
coloured lights wedel towels
essential oils **loudspeaker**
soapstone hair turban inserts
TPE floor mat sauna pillows
cleaning accessories **heaters**

H E A T T E C H N O L O G Y & L I G H T



Upon request, we can supply the entire EOS range



Sauna Heater Gracil Floor-Standing Model

Space-saving, sturdy, and modern, this heater is ideal for narrow cabins and installations in front of glass surfaces.

Featuring an integrated connection box, flat rear, and triple-shell design with an anthracite-coloured powder coating and brushed stainless steel top.

Sauna stones included,
Stone basket vol. approx. 20 kg
Connection: 400 V 3N ~ 50 Hz.

Technical Data Sheet:



Dimensions approx.: H x W x D: 76 x 50.5 x 25 cm

1 6 kW (4 x 1.5 kW) Item-No. 9308-1

2 7.5 kW (5 x 1.5 kW) Item-No. 9308-2

3 9 kW (6 x 1.5 kW) Item-No. 9308-3

Heating Coil for Sauna Heater Gracil

4 1.5 kW Item-No. 9308-99

Sauna Heater P 1+ Floor-Standing Model

This compact, durable sauna heater is designed for commercial use. It provides rapid heating times thanks to optimal air convection and features a robust stainless steel construction with an anthracite powder coating and adjustable feet.

It has dual-circuit wiring and a base with drip tray construction. LSG 10 required.

Sauna stones included,
Stone basket vol. approx. 40 kg
Connection: 400 V 3N ~ 50 Hz.

Technical Data Sheet:



Dimensions approx.:

H x W x D: 72 x 63 x 38 cm

5 12 kW (6 x 2.0 kW) Item-No. 9311-1

6 15 kW (6 x 2.5 kW) Item-No. 9311-2

Heating Coil for Sauna Heater P 1+

7 please specify kW number Item-No. 9311-99

Item description	kW	Item number	Unit price	from 3 pieces	from 10 pieces	from 25 pieces	from 50 pieces
1	6 kW	9308-1					
2 Sauna Heater Gracil, Floor-Standing Model	7.5 kW	9308-2					
3	9 kW	9308-3					
4 Heating Coil for Sauna Heater Gracil	1.5 kW	9308-99					
5 Sauna Heater P 1+, Floor-Standing Model	7.5 kW	9311-1					
6	9 kW	9311-2					
7 Heating Coil Sauna Heater P 1+		9311-99					

All prices apply only to industry, trade, craft and commerce and are subject to VAT ex warehouse. No minimum quantity surcharge.



Sauna Heater Herkules S60 Floor-Standing Model

A powerful sauna heater for commercial use. It offers high temperature stability and intense steam experiences thanks to the high heat storage capacity of the stone basket.

Features a premium matte black coating and a protective cover made of Abachi wood. The flat back design allows for installation in front of glass surfaces. LSG 10 required.

Sauna stones included,
Stone basket vol. approx. 60 kg
Connection: 400 V 3N ~ 50 Hz.

Technical
Data Sheet:



Dimensions approx.: H x W x D: 85 x 51 x 53 cm.

1 **NEW** 12 kW (9 x 1.33 kW) **Item-No. 9324-1**

2 **NEW** 15 kW (9 x 1.66 kW) **Item-No. 9324-2**

Heating Coil for Sauna Heater Herkules S60

3 **NEW** please specify kW number **Item-No. 9324-99**

EOS
INNOVATIVE SAUNA TECHNOLOGY



Heater Sensor Replacement Sensor

Replacement heater sensor including safety temperature limiter. Each Econ sauna control unit comes equipped with a heater sensor.

Dimensions approx.: 4.5 x ø 4.5 cm.



Item-No. 9371-2



Bench Sensor 2nd Temperature Sensor

Includes sensor housing and 6 m silicone cable for more precise temperature regulation in combination with the Econ D4 control unit.

Dimensions approx.: 4.5 x ø 4.5 cm.



Item-No. 9371-3

Item description	kW	Item number	Unit price	from 3 pieces	from 10 pieces	from 25 pieces	from 50 pieces
1 Sauna Heater Herkules S60, Floor-Standing Model	12 kW	9324-1					
2 Sauna Heater Herkules S60, Floor-Standing Model	15 kW	9324-2					
3 Heating Coil for Sauna Heater Herkules S60		9324-99					
4 Heater Sensor		9371-2					
5 Bench Sensor		9371-3					

All prices apply only to industry, trade, craft and commerce and are subject to VAT ex warehouse. No minimum quantity surcharge.



Sauna Heater 34.G HD Floor-Standing Model

Free-standing heater for Finnish saunas in a classic stainless steel design. The large gap between the stone basket and the outer shell ensures optimal air convection and rapid heat-up times.

Standard wiring with copper bus-bars makes this heater ideal for intensive commercial use. LSG required.

Sauna stones included,
Stone basket vol. approx. 30 kg
(15 - 21 kW) or 45 kg (24 - 36 kW).
Connection: 400 V 3N ~ 50 Hz.

Dimensions approx.:

H × W × D: 95 × 75 × 53 cm (15 - 21 kW).
H × W × D: 95 × 100 × 53 cm (24 - 36 kW).

Technical
Data Sheet:



1		NEW	15 kW (5 × 3.0 kW)	Item-No. 9312-1
2		NEW	18 kW (6 × 3.0 kW)	Item-No. 9312-2
3		NEW	21 kW (7 × 3.0 kW)	Item-No. 9312-3
4		NEW	24 kW (8 × 3.0 kW)	Item-No. 9312-4
5		NEW	27 kW (9 × 3.0 kW)	Item-No. 9312-5
6		NEW	30 kW (10 × 3.0 kW)	Item-No. 9312-6
7		NEW	36 kW (12 × 3.0 kW)	Item-No. 9312-7
Heating Coil for Sauna Heater 34.G HD				
8		NEW	3 kW	Item-No. 9312-99
These optional top frames allow you to increase the stone capacity by 30 to 45 kg.				
9		NEW	for 15 - 21 kW heater, 30 kg basket	Item-No. 9312-8
10		NEW	for 24 - 36 kW heater, 45 kg basket	Item-No. 9312-9

Item description	kW	Item number	Unit price	from 3 pieces	from 10 pieces	from 25 pieces	from 50 pieces
1	15 kW	9312-1					
2	18 kW	9312-2					
3	21 kW	9312-3					
4	Sauna Heater 34.G HD	9312-4					
5	27 kW	9312-5					
6	30 kW	9312-6					
7	36 kW	9312-7					
8	Heating Coil for Sauna Heater 34.G HD	9312-99					
9	15 - 21 kW	9312-8					
10	24 - 36 kW	9312-9					

All prices apply only to industry, trade, craft and commerce and are subject to VAT ex warehouse. No minimum quantity surcharge.

Heavy Duty
for intensive commercial use

Sauna Heater Goliath HD

Highly stable, reinforced construction entirely made of stainless steel. Wall structure in a three-layer design. Outer casing finished in anthracite powder coating. Features an extra-large stone basket.

Low operating and maintenance costs. LSG required.

Standard wiring with solid copper busbars, making it particularly suitable for intensive commercial use.

Sauna stones included,
Stone basket vol. approx. 75 kg.
Connection: 400 V 3N ~ 50 Hz.

Technical Data Sheet:

Dimensions approx.: H × W × D: 83 × 96 × 47 cm

1	18 kW (18 × 1 kW)	Item-No. 9315-1
2	24 (18 × 1.33 kW)	Item-No. 9315-5
3	30 kW (18 × 1.66 kW)	Item-No. 9315-6
4	36 kW (18 × 2 kW)	Item-No. 9315-7

Heating Coil for Sauna Heater Goliath HD

5	please specify kW number	Item-No. 9315-99
---	--------------------------	------------------

Item description	kW	Item number	Unit price	from 3 pieces	from 10 pieces	from 25 pieces	from 50 pieces
1	18 kW	9315-1					
2	24 kW	9315-5					
3	30 kW	9315-6					
4	36 kW	9315-7					
5	Heating Coil for Sauna Heater Goliath HD	9315-99					

All prices apply only to industry, trade, craft and commerce and are subject to VAT ex warehouse. No minimum quantity surcharge.



1
2

Sauna Control Unit Econ D2

Electronic control unit featuring a 24-hour real-time and pre-select timer. Temperature regulation range between 30°C and 115°C, with a safety temperature limiter set at 139°C. Heating time limit in short-term mode is 6 hours, extendable to 12 hours. Switching power of 9 kW, expandable with LSG.

Digital display for time, preset time, temperature, and remaining runtime. Includes key lock/child safety feature. Temperature sensor and sensor cable (2 m) included in the delivery.

Connection: 400 V 3 N AC 50 Hz

Dimensions approx.: H × W × D: 22 × 25 × 6.7 cm



Item-No. 9340-5

Sauna Control Unit Econ D4

as above, but heating time limit can be extended indefinitely.

Additional bench sensor connection available. Prepared for remote control functionality. Optional remote start module. Dimmable cabin light with 10 brightness levels. Output for cabin fan, adjustable (3 levels).

Connection: 400 V 3 N AC 50 Hz

Dimensions approx.: H × W × D: 22 × 25 × 6.7 cm



Item-No. 9340-7



Need replacement heating coils for your EOS sauna heater?
Simply email us at info@finnsa.de.



3

4

5

Power Switch Units for Expanding the Switching Capacity of the Sauna Control Device.

LSG 10 Switching Capacity 10 kW

Designed for use with control units featuring 9 kW (10 kW) switching capacity. Suitable for dual-circuit heaters with a total output of up to 19 kW (20 kW).

Dimensions approx.: H × W × D: 22 × 25.5 × 6.5 cm



Item-No. 9370-4

LSG 18 Switching Capacity 18 kW

Designed for use with control units featuring 9 kW (10 kW) switching capacity. Suitable for dual-circuit heaters with a total output of up to 27 kW (28 kW).

Dimensions approx.: H × W × D: 27 × 30 × 10 cm



Item-No. 9370-2

LSG 36 Switching Capacity 2 × 18 kW

Designed for use with control units featuring 9 kW (10 kW) switching capacity. Suitable for dual-circuit heaters with a total output of up to 45 kW (46 kW). Featuring an extra-large housing with an integrated fuse box.

Dimensions approx.: H × W × D: 45 × 30 × 14.2 cm



Item-No. 9370-3

Item description	Type	Item number	Unit price	from 3 pieces	from 10 pieces	from 25 pieces	from 50 pieces
1 Sauna Control Unit	Econ D2	9340-5					
2	Econ D4	9340-7					
3	LSG 10	9370-4					
4 Leistungsschaltgeräte	LSG 18	9370-2					
5	LSG 36	9370-3					

All prices apply only to industry, trade, craft and commerce and are subject to VAT ex warehouse. No minimum quantity surcharge.



Hazard

averted!

Sauna Heater Cover Protection System

According to DIN EN 60335, commercially used sauna heating devices must be equipped with safety cut-off switches. Enhance your EOS heater with this tested, standard-compliant safety solution.

Cut-Off Switch

The cover protection system consists of a stainless steel cut-off switch and a robust metal housing for the cut-off system designed for wall mounting directly above the sauna heater.

When the cover protection is pressed down, the heating process is interrupted. Once the object is removed, the operation resumes.

A mounting kit for free-standing heaters is available upon request.

Regulation
acc. to DIN EN
60335

Cut-Off Switch Type 3

For Sauna Heater P 1+.

Dim. approx.: H × W × D: 14 × 71 × 32.2 cm.



Item-No. 9300-2

Cut-Off Switch Type 4

For Sauna Heater Herkules S60.

Dim. approx.: H × W × D: 14 × 33.3 × 48.2 cm.



Item-No. 9300-3

Cut-Off Switch Type 5

For Sauna Heaters Goliath HD and 34.G HD.

Dim. approx.: H × W × D: 14 × 71 × 48.2 cm.



Item-No. 9300-4

Cut-Off Switch Type 6

For Sauna Heater Gracil.

Dim. approx.: H × W × D: 14 × 33.3 × 22.2 cm.



Item-No. 9300-5

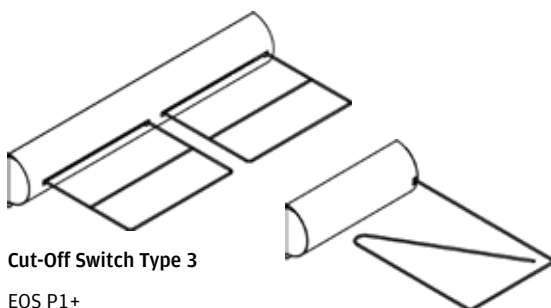

Cut-Off Switch Type 3

EOS P1+

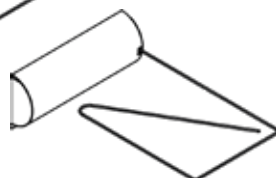

Cut-Off Switch Type 4

EOS Herkules S60

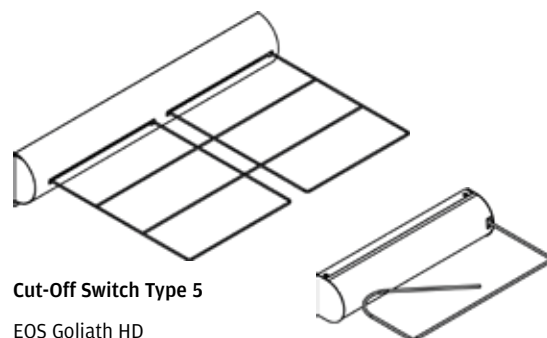

Cut-Off Switch Type 5

EOS Goliath HD
EOS 34.G HD

Cut-Off Switch Type 6

EOS Gracil

Item description

Type

Item number

Unit price

from 3 pieces

from 10 pieces

from 25 pieces

from 50 pieces

1

2

3

4

Cut-Off Switch

Type 3 9300-2

Type 4 9300-3

Type 5 9300-4

Type 6 9300-5

All prices apply only to industry, trade, craft and commerce and are subject to VAT ex warehouse. No minimum quantity surcharge.

Heart of the sauna heater

FINNSA Sauna Stones Volcanic Basalt/Diabase Rock



Part of FINNSA's range for over 40 years, these stones are the ideal choice for all sauna heaters.

Our sauna stones are also available in convenient nylon fabric big bags on pallets.

NOTE: Forklift required on-site.



Sauna Stones, medium

Sauna stones with a grain size of approx. 60 -120 mm.

- 1  10 kg carton, approx. 15-20 pieces Item-No. 6995
- 2  20 kg carton, approx. 30-35 pieces Item-No. 6990
- 3  250 kg Big Bag Item-No. 6992

Sauna Stones, large

Sauna stones with a grain size of approx. 60 -200 mm.

- 4  20 kg carton, approx. 10-15 pieces Item-No. 6991
- 5  250 kg Big Bag Item-No. 6993



medium size



large size



Item description	Weight	Item number	Unit price	from 3 pieces	from 10 pieces	from 25 pieces	from 50 pieces
1 FINNSA Sauna Stones, Basalt/Diabase,medium	10 kg	6995					
2	20 kg	6990					
3	250 kg	6992					
4 FINNSA Sauna Stones, Basalt/Diabase, large	20 kg	6991					
5	250 kg	6993					

All prices apply only to industry, trade, craft and commerce and are subject to VAT ex warehouse. No minimum quantity surcharge.



Enjoy Your Heater for Years to Come...

To ensure the longest possible lifespan of your heater, please consider the following:

- Adequate air supply and exhaust in the sauna cabin are essential for proper air circulation
- Water should not come into contact with the heating coil
- For water hardness greater than 1, use descaled water for steam systems
- When operating with steam systems, the maximum permissible temperature must be in relation to a specific humidity level



In the table below, you will find the heating power required for your cabin size.

What to consider when using sauna stones...

- Clean with water before use and ensure they are well dried before use
- Do not pour water on cold stones; water can settle in cracks and cause the stone to burst when heated
- Carefully pour warm water over hot stones
- Avoid experimenting with alcohol or unsuitable liquids or solids to prevent residues
- Periodically reshuffle the stones, removing small stones and crumbs. Stack the stones in a way that allows for good air circulation

Stones are a natural product—splitting is possible due to extreme heating and cooling.

Many defects in ovens or heating coils are attributed to "unmaintained" sauna stones.

Old stones absorb odours and residues, altering the fragrance of your infusion.

Cabin size in m ³	Heating Power in kW										
	6,0	7,5	9,0	12,0	15,0	18,0	21,0	24,0	27,0	30,0	36,0
6 - 8											
7 - 10											
9 - 14											
14 - 18											
18 - 25											
24 - 30											
24 - 34											
35 - 40											
40 - 50											
50 - 65											
65 - 75											

Gentle

infusions
with soapstones

Sauna Soapstone from Finland

Soapstone retains an immense amount of heat, creating a very pleasant atmosphere and allowing for gentle, even infusions.

Caution: Do not position soapstone directly on the heating coils.

1  15 kg carton

Item-No. 0860

Treat
your sauna
heater to
something
special!



Item description	Weight	Item number	Unit price	from 3 pieces	from 10 pieces	from 25 pieces	from 50 pieces
1 Sauna Soapstone	15 kg	0860					

All prices apply only to industry, trade, craft and commerce and are subject to VAT ex warehouse. No minimum quantity surcharge.

FINNSA Sauna Stones Reddish Porphyry

These sauna stones provide an extremely gentle sauna infusion and are ideal for all sauna heaters.

Our porphyry sauna stones are also available in a practical nylon fabric big bag on a pallet.

NOTE: Forklift required on-site.

Sauna stones with a grain size of approx. 40 - 130 mm.

1		20 kg carton	Item-No. 6970
2		250 kg Big Bag	Item-No. 6970-2

The
Eye-catcher
in your sauna



Sauna stones play a significant role in the quality of every sauna experience.

Ensure that your stones are regularly checked, re-stacked, and replaced.



Item description

Weight

Item number

Unit price

from 3 pieces

from 10 pieces

from 25 pieces

from 50 pieces

1

FINNSA Sauna Stones, Reddish Porphyry

20 kg

6970

2

250 kg

6970-2

All prices apply only to industry, trade, craft and commerce and are subject to VAT ex warehouse. No minimum quantity surcharge.

Finnish Sauna with

Kerkes

Original Ceramic Sauna Stones "Kerkes"

The sauna stones are fired at approximately 1300 °C, making them extremely durable and ideal for sauna use. They retain heat exceptionally well.

For wood-fired heaters, the balls are particularly suitable, while the tetra stones are ideal for electric heaters. In the lower section, use the larger Kerkes stones, and on top, a layer of smaller ones.

Generally, they come in packages of 10 kg.

1 + Tetras, ø 60 mm, approx. 35 pcs. **Item-No. 1220**

2 + Tetras, ø 80 mm, approx. 20 pcs. **Item-No. 1221**

3 + Balls, ø 50 mm, approx. 60 pcs. **Item-No. 1225**

4 + Balls, ø 60 mm, approx. 35 pcs. **Item-No. 1226**

Info

Many Finnish saunas use Kerkes stones.

For your
wood or
electric
heater



Item description	Diameter	Item number	Unit price	from 3 pieces	from 10 pieces	from 25 pieces	from 50 pieces
1 Ceramic Sauna Stones "Kerkes", Tetras	60 mm	1220					
2 Ceramic Sauna Stones "Kerkes", Tetras	80 mm	1221					
3 Ceramic Sauna Stones "Kerkes", Balls	50 mm	1225					
4 Ceramic Sauna Stones "Kerkes", Balls	60 mm	1226					

All prices apply only to industry, trade, craft and commerce and are subject to VAT ex warehouse. No minimum quantity surcharge.

The perfect *Stone* for your infusion

Sauna stones not only create steam during the infusion, but they also help to balance temperature fluctuations in the sauna due to their heat-retaining properties.

To assist you in making a selection, we present our various types of stones below:



Basalt

The dark grey basalt is a type of volcanic rock and a favorite in saunas. It is an excellent heat retainer, providing even and long-lasting warmth.

Diabase

The "old" basalt, also known as diabase, has properties comparable to conventional basalt but originates from a deeper rock layer and is harder. As a volcanic rock, it is ideal for use in a hot sauna.



Porphyry

As a volcanic magma rock, porphyry is highly heat-resistant and, with its red hue, stands out among sauna stones. It also retains heat well, ensuring a pleasant sauna experience.

Soapstone

The light stone is an excellent heat storage medium, effectively balancing temperature fluctuations in the sauna. Soapstone primarily consists of talc and serves as an aesthetic highlight in any sauna.



Ceramic

Firing at extreme temperatures of around 1300 °C creates a durable material that ensures a lasting and relaxing sauna experience. Ceramic is resistant to thermal shock and is used in many Finnish saunas.

Evaporator Stone "Saunakko"

Place among the sauna stones in the hottest spot and fill with infusion water.

Enjoy your own little sauna geyser.

Dimensions approx.: 6 cm high.



Item-No. 0810

Steam Stones with Boreholes

Steam stones with four cavities for infusion water, providing pleasant and consistent humidity in the sauna.

Dimensions approx.: 6 cm high.

Total capacity of all boreholes approx. 150 ml.



2 stones

Item-No. 0820

Sauna Spirit "Löylyhenki"

Place the "Spirit" on your sauna heater and pour some water into its lap.

Dimensions approx.: ø 8.5 cm, 11 cm high



Item-No. 0825

Fountain "Saunatroikka"

Place the Saunatroikka on your sauna heater. Like a fountain, it creates three water columns that bubble up depending on the temperature of the stones.

Dimensions approx.: ø 8.5 cm, 9.5 cm high.



Item-No. 0840

Soapstone Candle Holder "Mystic"

Beautiful soapstone candle holder for tealights.

Dimensions approx.: 8 cm high.



Item-No. 0836



Item description

Item number

Unit price

from 3 pieces

from 10 pieces

from 25 pieces

from 50 pieces

1	Evaporator Stone "Saunakko"	0810				
2	Steam Stones with Boreholes	0820	set of 2			
3	Sauna Spirit "Löylyhenki"	0825				
4	Fountain "Saunatroikka"	0840				
5	Soapstone Candle Holder "Mystic"	0836				

All prices apply only to industry, trade, craft and commerce and are subject to VAT ex warehouse. No minimum quantity surcharge.

Exclusive Solid Wood Sauna Light "Malmö" Wall/Corner Model Made of Abachi Wood

This light fixture can be easily retrofitted in any sauna. The ceiling light 8021 is included. The supplied mounting block is attached to the sauna wall with 2 screws.

The lampshade is then hung on it and can be removed at any time without tools.

Comes complete with shade, mounting block, and inner light 8021.

Dim. approx.: W × H × D: 25.5 × 38 × 12.5 cm,
Side Panels: 3.1 cm, Lid Panel: 2.2 × 23.2 cm.

1  complete Item-No. 7065

as above, but only shade and mounting block.

2  shade + mounting block Item-No. 7065-1



Corner
mounting with
mounting block

Wall mounting with
mounting block

High-Quality Sauna

Lights

from FINNSA

Wall Shade "Salo" Lampshade

Solid alder wood, finely crafted, compatible with our 4 ceramic lights (see page 170).

Dimensions approx.: W × H × D: 30 × 32 × 16 cm.

3  Item-No. 8850

Corner Shade "Oslo" Lampshade

as above, but corner shade.

Dimensions approx.: W × H × D: 27 × 32 × 12.5 cm

4  Item-No. 8851



Item description

Item number

Unit price

from 3 pieces

from 10 pieces

from 25 pieces

from 50 pieces

1	Sauna Light, Wall/Corner Model "Malmö"	complete	7065				
2		shade	7065-1				
3	Wall Shade "Salo"		8850				
4	Corner Shade "Oslo"		8851				

All prices apply only to industry, trade, craft and commerce and are subject to VAT ex warehouse. No minimum quantity surcharge.

shedding Light on the matter



Sauna Corner Light "Porvoo"

High-quality, very stable corner light with a low installation depth. Suitable for ambient temperatures up to 115°C.

Delivery includes: glare shield, metal wall mount, interior light 1110, and mounting materials.

Socket E14. Up to 30 watts. Only use candle-shaped bulbs.



Dim. appr.: H×W×D: 33×22.3×17.5 cm.

- 1**  complete (IP44) Item-No. 1125
- 2**  replacement shade Item-No. 1112

Sauna Wall Light "Mikkeli"

as above, but wall model.

Dim. appr.: H×W×D: 33×26×12.2 cm.

- 3**  complete (IP44) Item-No. 1120
- 4**  replacement shade Item-No. 1111

Spare Interior Light "Porvoo" & "Mikkeli"

Heat-resistant plastic base with cover glass. Maximum 30 W, E14, suitable for temperatures up to 115 °C. IP44.

Only use candle-shaped bulbs.

Dim. appr.: L×W×H: 20×10×8 cm.

- 5**  Item-No. 1110



Item description	Item number	Unit price	from 3 pieces	from 10 pieces	from 25 pieces	from 50 pieces
1 Sauna Corner Light, "Porvoo"	complete	1125				
2	shade	1112				
3 Sauna Wall Light, "Mikkeli"	complete	1120				
4	shade	1111				
5 Spare Interior Light "Porvoo" and "Mikkeli"		1110				

All prices apply only to industry, trade, craft and commerce and are subject to VAT ex warehouse. No minimum quantity surcharge.

Sauna Wall Light "Quadro"

Robust and timeless sauna light. Heat-resistant plastic base suitable for temperatures up to 125 °C.

E 27, 40 or 60 watts.
Glass cover ø 19.4 cm.

Dim. appr.: H×W×D: 25×25×13.5 cm.

1 + complete (IP44) Item-No. 1130

2 + replacem. shade Item-No. 1131



Spare Interior Light for "Quadro"

Heat-resistant plastic base with large glass cover. Suitable up to 125 °C. E27, 40 or 60 watts.

IP44, **Dim. appr.:** ø 19.5 cm, H 10.5 cm.

3 + Item-No. 1132

Sauna Interior Light "Raita"

Attractive, practical, versatile, and easy to install. Wall or corner mounting options available.

The cover is adjustable and made of 5 layers of pine wood veneer. Untreated, it can be stained.

Suitable for temperatures up to 125 °C. E27, 40 watts.

Dim. appr.: H×W×D: 23×15.7×11 mm.

4 + complete (IP44) No. 111010

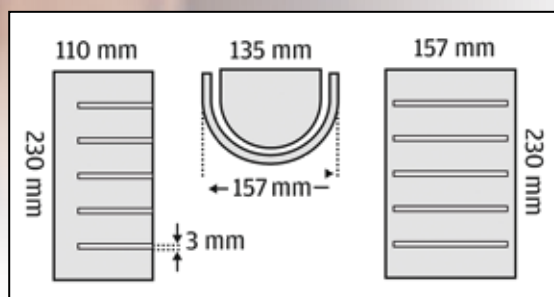

Only have it installed by a professional. Mount with a gap to the ceiling to avoid heat buildup.

Please use only standard incandescent or oven bulbs. Energy-saving lamps are not suitable for sauna lighting.

Item description	Item number	Unit price	from 3 pieces	from 10 pieces	from 25 pieces	from 50 pieces
1 Sauna Wall Light, "Quadro"	complete 1130					
2	shade 1131					
3 Replacement Interior Light "Quadro"	1132					
4 Sauna Interior Light, "Raita"	complete 111010					

All prices apply only to industry, trade, craft and commerce and are subject to VAT ex warehouse. No minimum quantity surcharge.

Sauna Light

Ceramic base, white with glass. Suitable for a maximum temperature of 125 °C. When used as a ceiling lamp, maximum 40 W E27; when used as a wall lamp, maximum 60 W E27.

Dim. approx.: 13 cm long, Ø glass 8.5 cm.

1  bevelled, IP54 matte **Item-No. 8020**

as above, but with clear glass.

2  bevelled, IP54 clear **Item-No. 8020-1**

as above, but 13.5 cm long and straight.

3  straight, IP54 matte **Item-No. 8021**

as above, but with clear glass.

4  straight, IP54 clear **Item-No. 8021-1**



Light Bulb for Sauna Lights

These bulbs, designed for high temperatures, are ideal for saunas.

Round globe shape. Packed individually in a box. Energy efficiency class E. 230 V, 40 W, up to 300 °C.

5  E 14 **Item-No. 8051**

6  E 27 **Item-No. 8052**



Halogen Bulb for Sauna Light 1110

Halogen. Candle shape. Packed individually in a box. Energy efficiency class C.

230 V, 28 W (equivalent to 35 W), length approx. 10 cm including the thread.

7  E 14 **Item-No. 8053**



Halogen Bulb

Halogen. Teardrop shape. Packed individually in a box. Energy efficiency class C.

230 V, 28 W (equivalent to 35 W), length approx. 7.5 cm including the thread.

8  E 27 **Item-No. 8054**



Light bulbs are excluded from the warranty.

Item description	Item number	Unit price	from 3 pieces	from 10 pieces	from 25 pieces	from 50 pieces
1 Sauna Light, bevelled	matte 8020					
2 Sauna Light, bevelled	clear 8020-1					
3 Sauna Light, straight	matte 8021					
4 Sauna Light, straight	clear 8021-1					
5 Sauna Light Bulb, globe shape	E 14 8051					
6 Sauna Light Bulb, globe shape	E 27 8052					
7 Halogen Bulb, candle shape	E 14 8053					
8 Halogen Bulb, teardrop shape	E 27 8054					

All prices apply only to industry, trade, craft and commerce and are subject to VAT ex warehouse. No minimum quantity surcharge.

... how Colours touch People



Wooden frame made of alder.

- red,** embodies passion, fire, and strength, and may have a revitalising effect.
- yellow,** the colour of the sun, is believed to invigorate and uplift our mood.
- green,** serves as the base tone of nature, promoting emotional balance.
- blue,** is said to provide relaxation as the colour of the sky and sea.

For more information, visit www.collaxx.com.

Installation

collaxx colour light devices are perfect for retrofitting. Simple installation with just two screws.

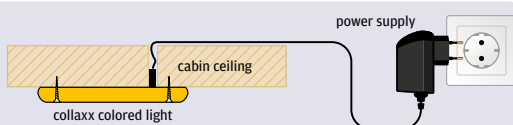

LED Technology - Unique, Efficient, Innovative

Activate your energy centres with the positive effects of light.

- Absolutely flicker-free
- Uniform light surface
- 30,000 hours LED lifespan

collaxx Colour Light Devices Impress with Radiant Benefits



Temperature resistant up to 125 °C

The unique HEAT PROOF TECHNOLOGY.



High Brightness

Intense brightness suitable for all types of infrared and sauna cabins.



Light Properties

8 colours. Gentle colour transitions. All models are dimmable.



Large Saunas

Control multiple colour light devices simultaneously with one remote control.



Service

At www.collaxx.com, you can download relaxation journeys under "Moodies" and discover how the colours affect you with the colour guide.

Maintenance-Free Long-Life Batteries

When used correctly, the high-temperature resistant battery for the remote control lasts over 10 years. For this reason, no maintenance is required.







Classic Coloured Light Device in a Proven Design

With its gently rounded edges, this versatile classic fits harmoniously into the sauna cabin.

- For cabins up to 3.5 × 3.5 m in floor area
- Switching and dimming via remote
- Synchronised operation is possible
- Designed for commercial use
- 90 power LEDs from Osram

Dim. appr.: 36.3 × 26.7 × 3.5 cm, 900 g, 34 W, Brightness of up to 460 lm. Includes remote.

- | | | |
|----------|--|------------------------|
| 1 |  Alder | Item-No. 8330 |
| 2 |  Abachi | Item-No. 8330-2 |
| 3 |  Cedar | Item-No. 8330-3 |
| 4 |  Aspen | Item-No. 8330-4 |



Striking Coloured Light Device with Sharp Edges

- For cabins up to 2.5 × 2.5 m in floor area
- No ceiling cut-out required
- On/off and dimming via remote control
- Easy installation
- 56 Power LEDs from Osram

Dim. appr.: 32 × 23.5 × 3.5 cm, 730 g, 21 W, Brightness of up to 290 lm. Includes remote.

- | | | |
|----------|--|----------------------|
| 5 |  Erle | Item-No. 8321 |
|----------|--|----------------------|

Round Coloured Light Device for Small Saunas and Infrared Cabins

- For cabins up to 1.3 × 1.3 m in floor area
- Touch control
- 18 Power LEDs from Osram

Dim. appr.: ø 13.5 × 3.5 cm, 125 g, 16 W, Brightness of up to 96 lm.

- | | | |
|----------|---|----------------------|
| 6 |  | Item-No. 8340 |
|----------|---|----------------------|

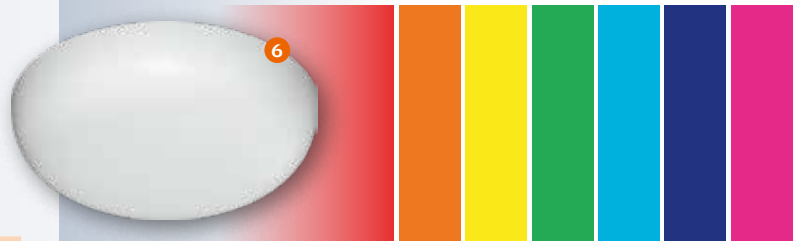

Item description	Material	Item number	Unit price	from 3 pieces	from 10 pieces
1	Alder	8330			
2	Abachi	8330-2			
3	Cedar	8330-3			
4	Aspen	8330-4			
5	Alder	8321			
6		8340			

All prices apply only to industry, trade, craft and commerce and are subject to VAT ex warehouse. No minimum quantity surcharge.

Modular Coloured Light Bar Set

Play with Possibilities

Indirect lighting for saunas and infrared cabins. Installation in visible areas using cover clips.

- Directly connectable & flush mountable
- Compatible with all devices
- Designed for commercial use
- Control & dimming via remote control

Standard length silicone connection cables are included. Cables in other lengths available upon request.

Dim. approx.: each bar 49 × 1.5 × 1.5 cm, 61 g, 6 LED watts, Brightness up to 120 lm. Includes remote control.

1  4 × 49 cm Coloured Light Bar Set

Item-No. **8360**

Light bars available upon request in lengths from 0.2 to 3.53 m!

Other
Light Bars
upon request

Handheld Remote Control

4-Button Wireless Remote Control

- Operating Modes: Automatic, Next Colour, Brightness, Dimming
- Continuously dimmable, 7 colours adjustable
- Programmable colour change
- Compatible with all collaxx devices
- Maintenance-free long-life battery
- High-temperature resistant
- Easy to retrofit

Dim. approx.: 7.5 × 3.9 × 1.6 cm, 25 g, IP54.

NOTE: Please keep the remote control safe and do not throw it!

2 

Item-No. **8380**

Wall Remote Control

for Inside and Outside the Cabin



as above, but for wall mounting.

Available in more than 10 additional wood types with a lead time.

Dim. approx.: 5.5 × 5.5 × 1 cm, 40 g, IP44.

3  Alder

Item-No. **8380-2**

	Item description		Item number	Unit price	from 3 pieces	from 10 pieces
1	 collaxx Modular Coloured Light Bar Set	4 × 49 cm	8360			
2	 collaxx Handheld Remote Control		8380			
3	 collaxx Wall Remote Control	Alder	8380-2			

All prices apply only to industry, trade, craft and commerce and are subject to VAT ex warehouse. No minimum quantity surcharge.

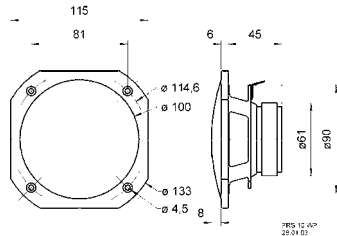

Technical Data:
 Nominal Power Handling: 25 watts
 Music Power Handling: 50 watts
 Impedance: 8 Ω
 Frequency Response (-10 dB): 90-19000 Hz
 Avg. Sound Pressure Level: 90 dB (1 W/1 m)
 Net Weight: 360 g

Broadband Speaker FRS 10 WP for Sauna, 10 cm (4")

Features glass fiber membrane, plastic basket, and grille. With balanced frequency response and high efficiency with good mid and high tone reproduction

Permanent weather resistance makes it especially suitable for outdoor areas, swimming pools, saunas, and as built-in speakers for boats, ships, and open vehicles

- Functional at low temperatures
- Suitable for humid environments, seawater-resistant
- Temperature resistant up to 120 °C, material: PC (UL 94: V-0)

1 white Item-No. 5950-1

2 black Item-No. 5950-2

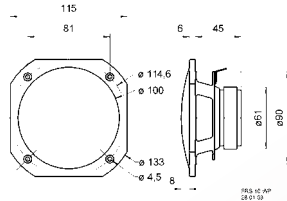

Technical Data:
 Nominal Power Handling: 40 watts
 Music Power Handling: 60 watts
 Impedance: 4 Ω
 Frequency Response (-10 dB): 70 - 16000 Hz
 Avg. Sound Pressure Level: 85 dB (1 W/1 m)
 Net Weight: 290 g

Broadband Speaker FR 13 WP Universal, 13 cm (5")

Featuring an injection-moulded plastic diaphragm, along with a plastic basket and grille. Completely corrosion and water-resistant due to the magnetic covering and silicone insulation of the connection lead. Clear high-frequency reproduction. Suitable for outdoor installations.

- Operational at low temperatures,
- suitable for damp environments, seawater resistant.
- Temperature resistant up to 80 °C, plastic: ASA (UL 94: HB)

3 white Item-No. 5952-1

4 black Item-No. 5952-2

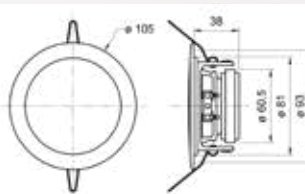

Technical Data:
 Nominal Power Handling: 10 watts
 Music Power Handling: 30 watts
 Impedance: 8 Ω
 Frequency Response (-10 dB): 100-2000 Hz
 Avg. Sound Pressure Level: 84 dB (1 W/1 m)
 Net Weight: 330 g

Ceiling Speaker DL 8 ES Universal, 8 cm (3,3")

Ceiling speaker made of brushed stainless steel. Suitable for installation in suspended ceilings of all materials. Efficient installation in a circular cut-out with spring clips, electrical connection via push-fit terminal.

- Functional at low temperatures
- Suitable for outdoor use, UV-resistant
- Designed for installation in suspended ceilings in humid areas and heat cabins

5 brushed stainless steel Item-No. 5954

Item description	Colour	Item number	Unit price	from 3 pieces	from 10 pieces	from 25 pieces	from 50 pieces
1 Loudspeaker FRS 10 WP	white	5950-1					
2 Loudspeaker FRS 10 WP	black	5950-2					
3 Loudspeaker FR 13 WP	white	5952-1					
4 Loudspeaker FR 13 WP	black	5952-2					
5 Loudspeaker DL 8 ES	stainless steel	5954					

All prices apply only to industry, trade, craft and commerce and are subject to VAT ex warehouse. No minimum quantity surcharge.